

# NATURAL WOODGRAIN SERIES

SWING DOOR



EXCLUSIVELY BROUGHT TO YOU BY VITALITY SDN. BHD.



## INSPIRATIONS

VITALITY has been the leading innovator and supplier of Eco Art Panel & Aluminium Home Products in Malaysia since 1993. We have great passion and take pride in delivering top quality works of art that offer exceptional beauty to inspire the home owners and professional designers. There are always industry leading durable products from Vitality that would tug at your heartstring and enrich your living space. As time changes, one thing remains certain – our customers can always expect high quality products and services from Vitality.

All products that bear the Vitality trademark have gone through strict quality control to enable all our customers to enjoy the luxury, elegance and quality for which Vitality has become renowned.

Vitality Eco Art Panels are impressively designed to reflect a unique understanding of the ever-changing contemporary styles, while the quality ensures that they are not only durable but long lasting. It is ideal for bathroom doors, kitchen doors, shower enclosure panels, partitions, wardrobe doors and cabinet doors. For most things you have in mind, whether to renovate, spruce up or retouch your home, at Vitality, we have it all covered.

You will be inspired by Vitality Eco Art Panels eye-catching designs in this catalogue. The countless design possibilities inherent in our home series will surely bring to your living space fresh new inspirations and a touch of elegance. Whereas a wealth of ideas in our commercial series will help to create a beautiful, functional working space that reflects your very own personal style.

You will find countless of wonderful and brilliant new designs in just a few flips away. Let's start turning your dreams of living or working space into a reality!



## VITALITY'S COMMITMENT TO QUALITY ASSURANCE

Vitality is committed to offer unrivalled levels of competence in Eco Art Panels and Aluminium Home Products development and technology. We conform to the highest standards in all aspects in order to support our customers locally and internationally. We continuously provide the best quality, highest value in each of our product, and thus, our customers could enjoy a peace of mind in their daily lives.

You will find all Vitality personnel to be reliable, innovative and resourceful – the success factors of an industry innovator!

We are honoured with these prestigious awards:



### INTELLECTUAL PROPERTY NOTICE

All materials, including texts, images, trademarks, logos, designs, graphics, photographs, and other materials that appear in this brochure are properties owned or licensed by Vitality Sdn. Bhd. and/or its related parties, and are protected under copyright law, trademark law or other intellectual property laws, and all such rights are reserved. The contents of this brochure, and this brochure as a whole, may not be scanned, reproduced, adapted, modified, published, or distributed, in whole or in part, without the prior written consent of Vitality Sdn. Bhd. or its related parties.

© 2021 Vitality Sdn. Bhd. ("Vitality"). All Rights Reserved.  
Proudly designed and published by Vitality Sdn. Bhd. 200801039521 (840870-K)



# CONTENTS

## Swing Door

- 12 Aerolite Panel with Swing Door
- 22 Aerolite Panel with Swing Door Louver Design
- 25 Aerolite Panel with Swing Door Lattice Design
- 40 Lamina Glass with Swing Door Lattice Design
- 46 Eco Art Panel with Swing Door
- 52 Eco Art Panel with Swing Door Lattice Design
- 54 Eco Art Panel with Swing Door Louver Design

## Bi-fold Door

- 57 Aerolite Panel with Bi-2 Door
- 62 Aerolite Panel with Bi-2 Door Louver Design
- 66 Aerolite Panel with Bi-fold Door
- 69 Eco Art Panel with Bi-fold Door

### Door Model Symbol



### Door Frame Colours Symbol

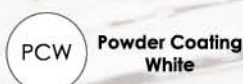

# Swing Door with Aluminium Accessories

全铝配件



Elegant frame design incorporated with a clean arc outline.

## Aluminium Square Half Deadbolt (optional)



● To enhance security and privacy.

## Aluminium Handle Lock

### Privacy Handle Lock

● This door handle comes with a keyless design. In case of an emergency, the door can be unlocked with a coin from the outside.



### Key Handle Lock

● For use in interior doors where keyed entry and security is needed.



# 830A



## Door Profile

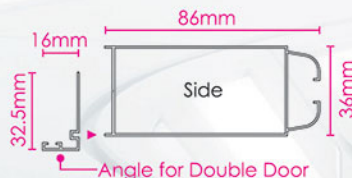

### Metal Rods Bolts



- Strengthen the structure of the door by keeping it in place and in shape.

### Profile Cover



- Protection from sharp edges.
- To cover the connection holes.

### Aluminium Hinges



- Door withstand up to 50kg.
- Hassle-free installation.
- Anodised Finishing.

### Door Colours

PCW

SBG

NA

PCMB

# 740A

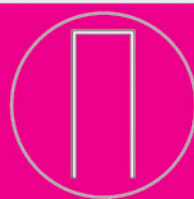

### Door Frame Profile

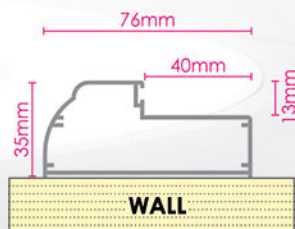

# SAFETY

## Aluminium Square Half Deadbolt

One-sided lockset with "thumb-turn" feature to ensure security and privacy.



# STRONG

## Metal Rods Bolts

Strengthen the structure of the door by keeping it in place and in shape.

**I'M STRONG!!**

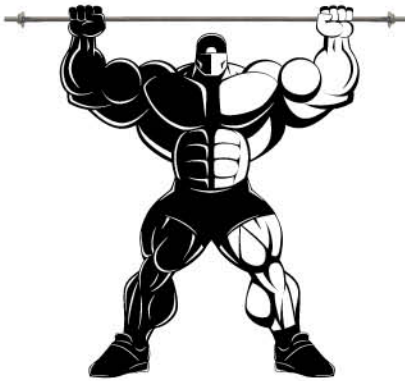

**With Metal Rods Bolts**  
**Vitaliy Swing Door**

**Without Metal Rods Bolts**

Horizontal Line

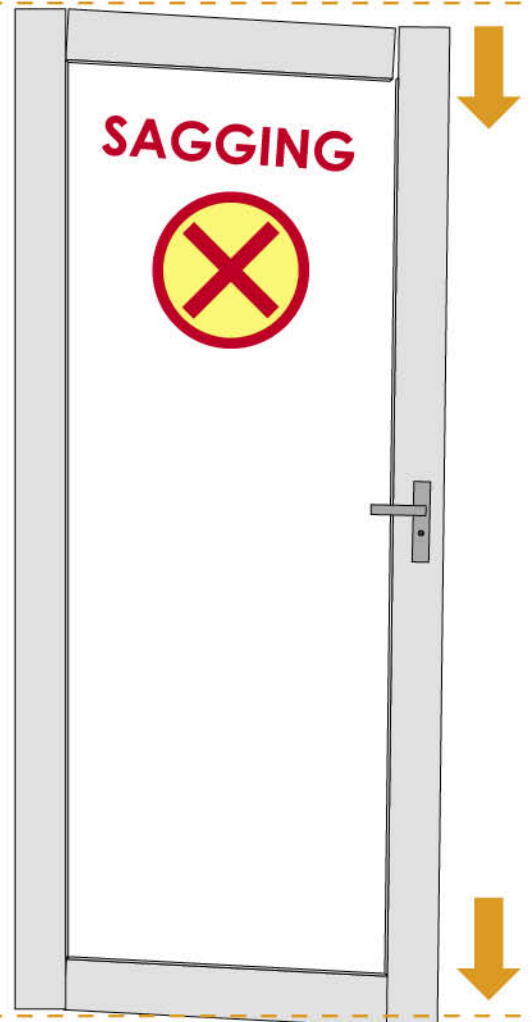
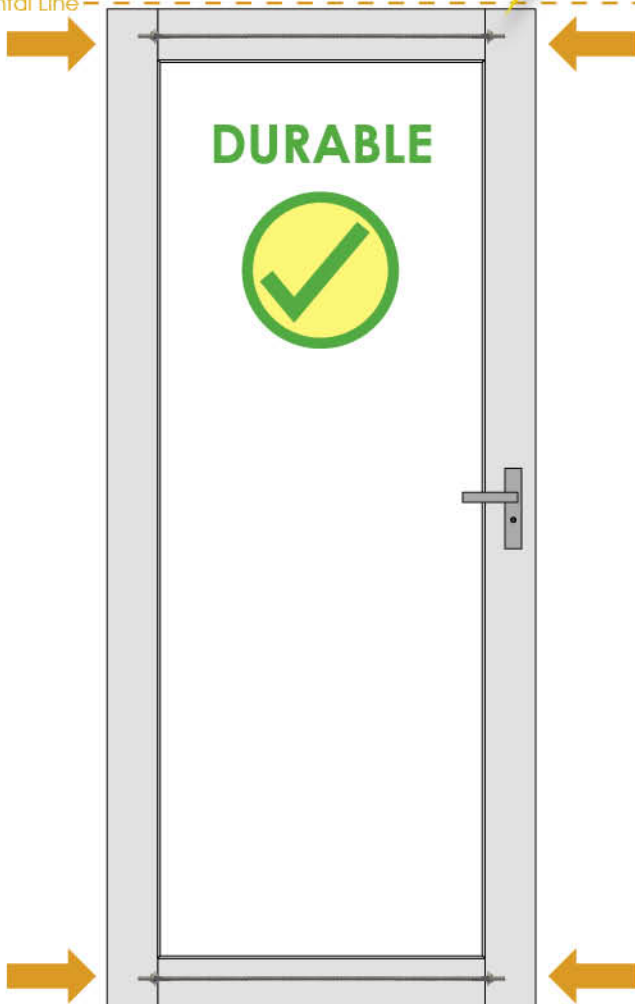

Horizontal Line

# LOUVER DESIGN



**BI-FOLD DOOR (BI-2)**

Louver Model: B2V02 (1/4)

Aerolite: AWG 214 /AWG 230



Special louver design provide

# GREAT VENTILATION

allowing air to flow through.

促进室内空气循环



Remove Odor

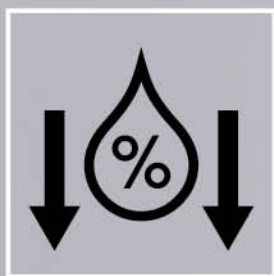

Reduce Humidity

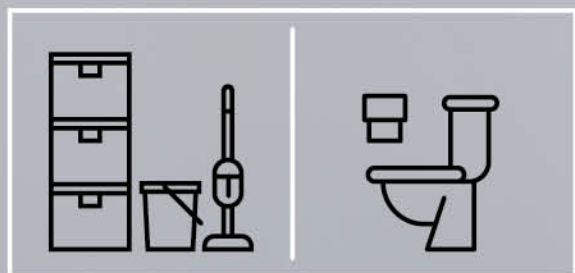

Best for Storeroom & Bathroom

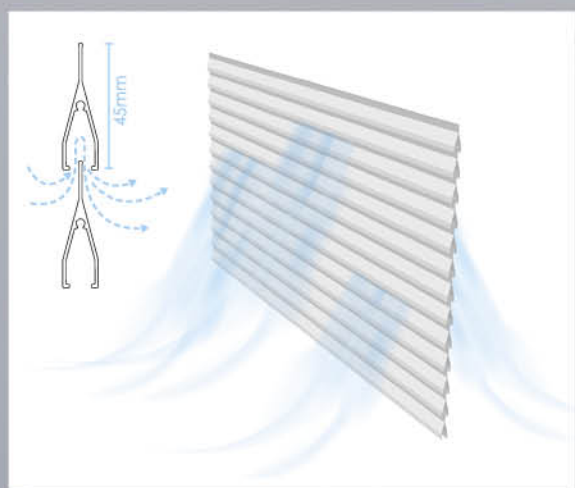

## SWING DOOR

Louver Model: SWV02 (1/4)



## aerolite™ Panel

Thickness: 3mm



Textured Surface



Double-faced



High Density



Impact Resistant



Balanced Thickness



Heat Resistant



Water Resistant



Anti-termite



Easy to Clean



## Lamina Glass

Thickness: 4mm or 5mm



Striking Colour



Balance Thickness



Water Resistance



Heat Resistance



Recyclable



## eco ART PANEL®

Thickness: 2.5mm



Eco Friendly



UV Finishing



0% VOC UV Printing



High Density Printing



Balance Thickness



Glossy Surface



Scratch Resistance



Impact Resistance



Water Resistance



Heat Resistance



3D Effect



Recyclable

# CHOOSE YOUR FAVORITE INFILL PANEL & PRODUCTS.

AWG 212

Swing Door

Bi-2 Door

Bi-fold Door



FC-7002

Swing Door

Bi-2 Door

Bi-fold Door



BM01077

Swing Door

Bi-2 Door

Bi-fold Door



# aerolite™

Double Faced • Natural Woodgrain • Textured Surface



FRONT VIEW

REAR VIEW

Aerolite Panel: AWG 218

# aerolite™ Panel



Fineline  
**AWG 201**



Waterfall Line  
**AWG 203**



All pictures shown are for illustration purpose only. Actual product may vary due to product enhancement.

# aerolite™ Panel



Alabaster Oak  
**AWG 204**



Natural Ash  
**AWG 205**



All pictures shown are for illustration purpose only. Actual product may vary due to product enhancement.

EXQUISITE

Aerolite: AWG 205

# aerolite™ Panel



All pictures shown are for illustration purpose only. Actual product may vary due to product enhancement.





Smoked Pine  
**AWG 210**



PCMB



Yellow Bamboo  
**AWG 211**



PCMB

# aerolite™ Panel



All pictures shown are for illustration purpose only. Actual product may vary due to product enhancement.



Sarum Strand  
AWG 214



Classic Oak  
AWG 215





# NATURAL WOODGRAIN

# aerolite™ Panel



Hazelnut Cherry  
**AWG 216**



Rattan Cane  
**AWG 217**



All pictures shown are for illustration purpose only. Actual product may vary due to product enhancement.

# aerolite™ Panel



All pictures shown are for illustration purpose only. Actual product may vary due to product enhancement.

## LOUVER DESIGN



LOUVER MODEL: **SWV02**

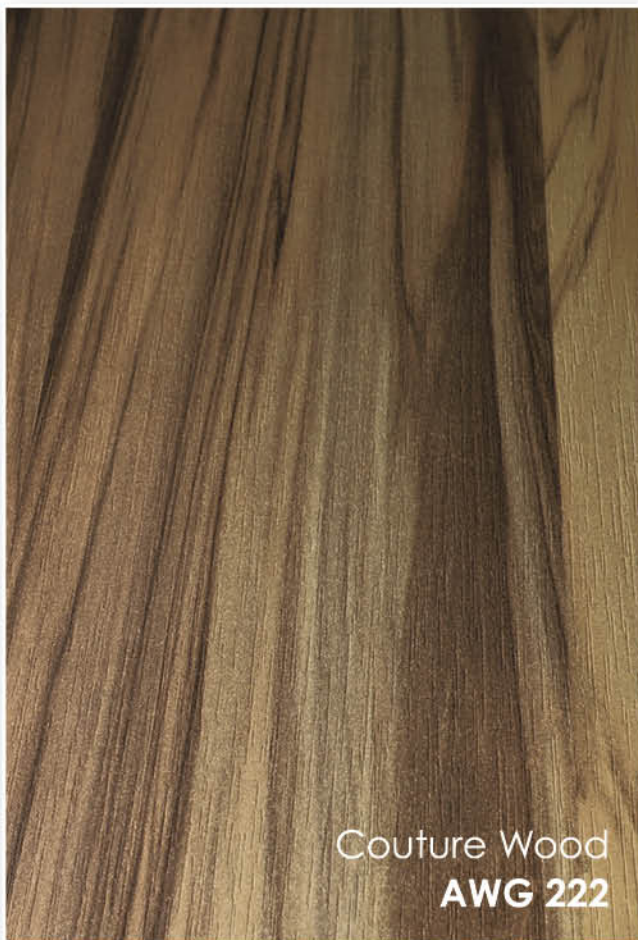

# aerolite™ Panel



LOUVER MODEL: **SWV02**



All pictures shown are for illustration purpose only. Actual product may vary due to product enhancement.



## LOUVER DESIGN



LOUVER MODEL: **SWV02**



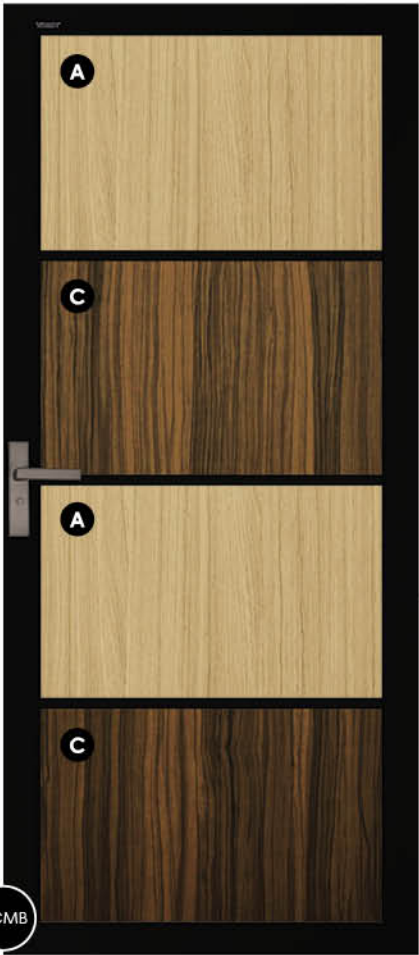
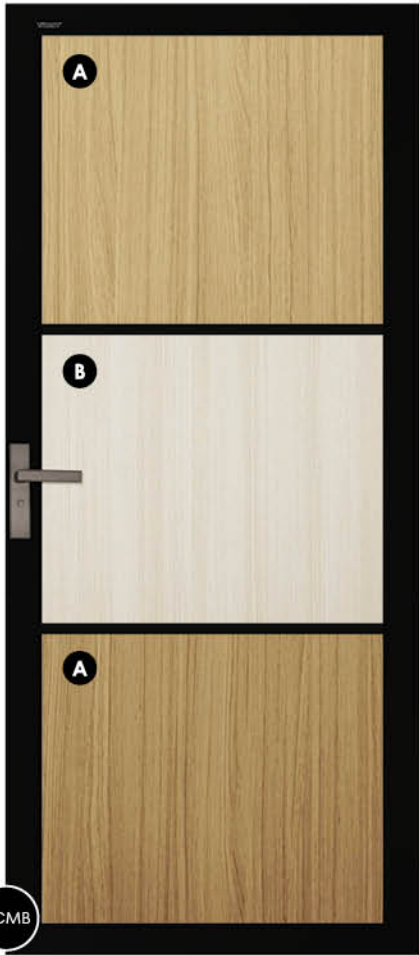
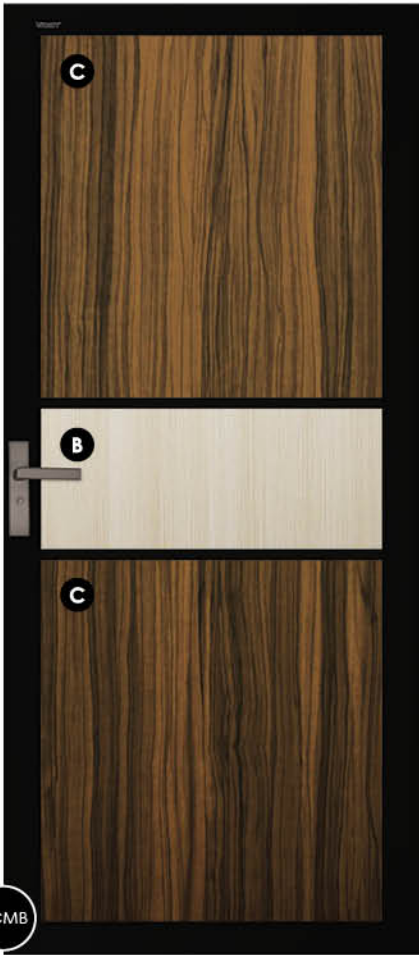

LATTICE MODEL: **SWC01**

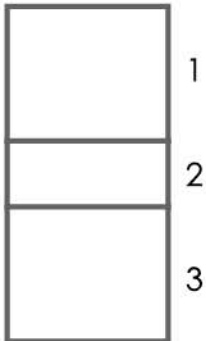

LATTICE MODEL: **SWC02**

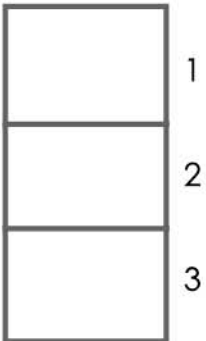

LATTICE MODEL: **SWC03**



All pictures shown are for illustration purpose only. Actual product may vary due to product enhancement.

# aerolite™ Panel

can be used on different products.



AWG 216

## SWING DOOR



## BI-2 DOOR



## BI-FOLD DOOR



# aerolite™ Panel

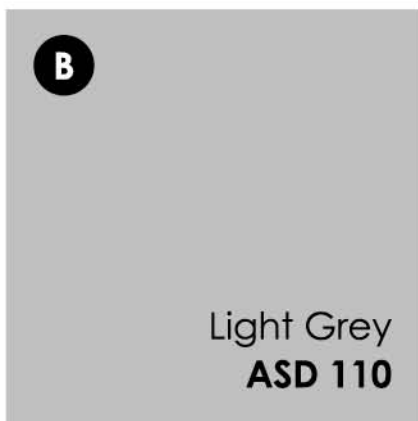

LATTICE MODEL: **SWC01**

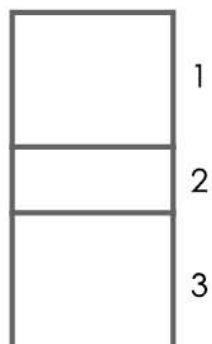

LATTICE MODEL: **SWC02**

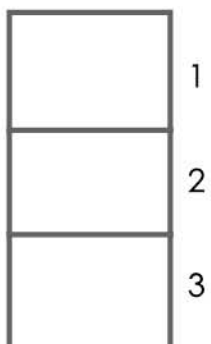

LATTICE MODEL: **SWC03**

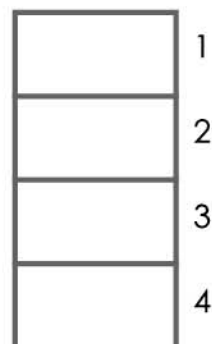

All pictures shown are for illustration purpose only. Actual product may vary due to product enhancement.

## LATTICE DESIGN

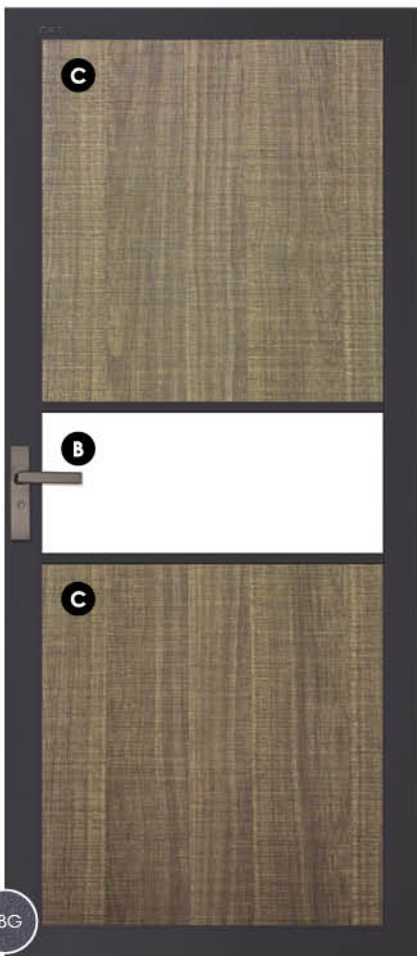
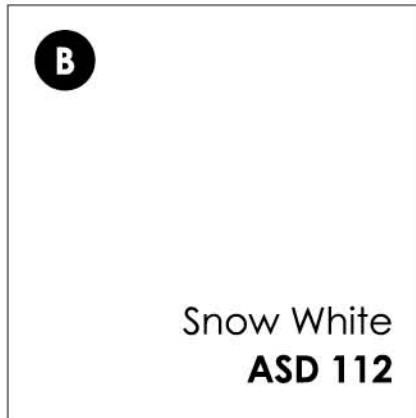

LATTICE MODEL: **SWC01**

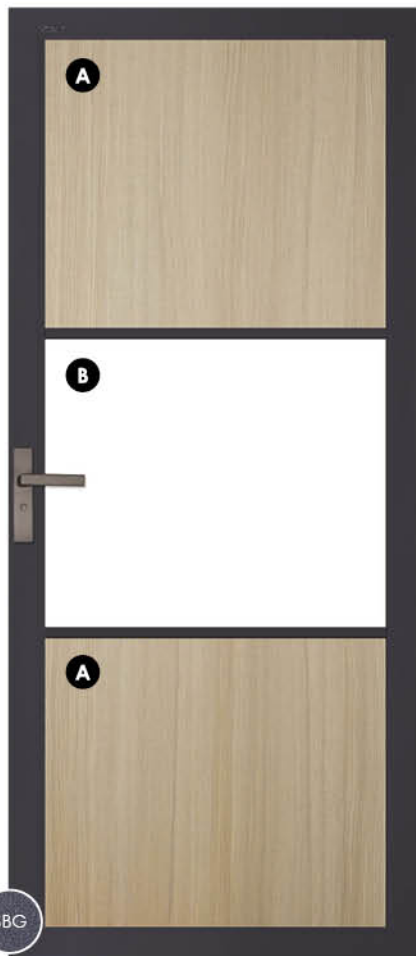

LATTICE MODEL: **SWC02**



LATTICE MODEL: **SWC03**

# AESTHETICS



Aerolite: AWG 219/ AWG 230

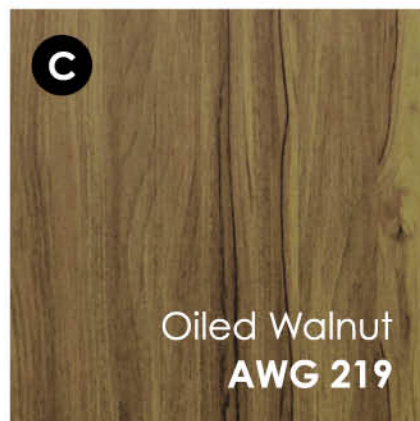
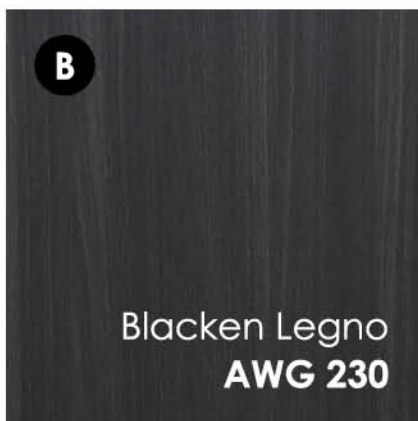
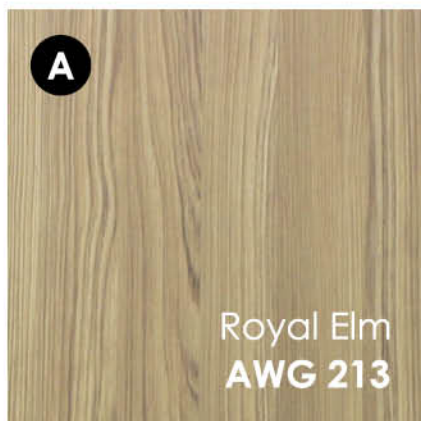

LATTICE MODEL: **SWC01**

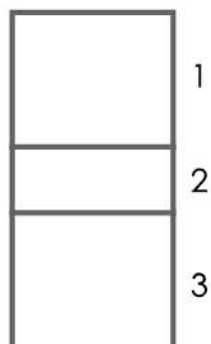

LATTICE MODEL: **SWC02**

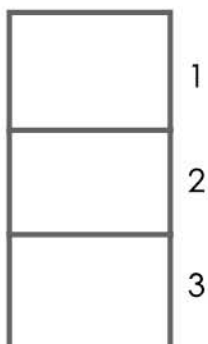

LATTICE MODEL: **SWC03**

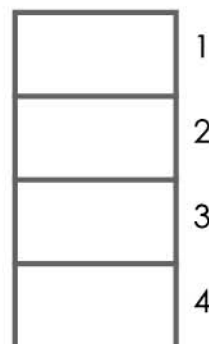



# RELAXING

Aerolite: AWG 211/ AWG 217



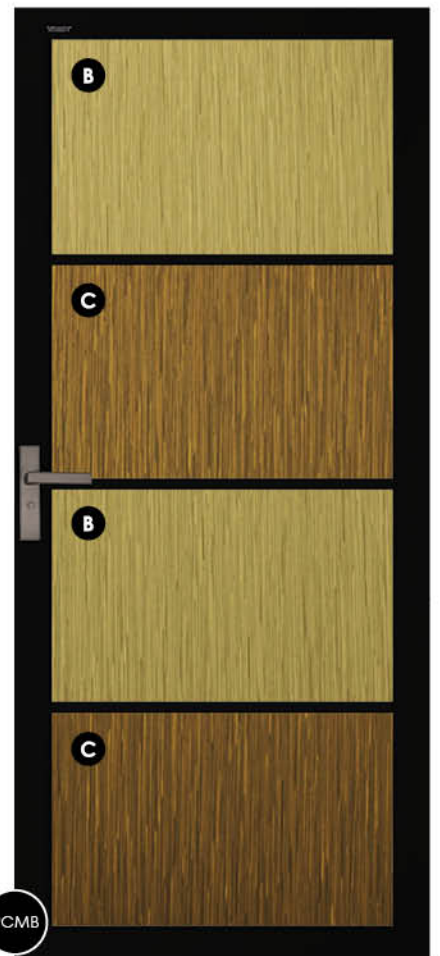
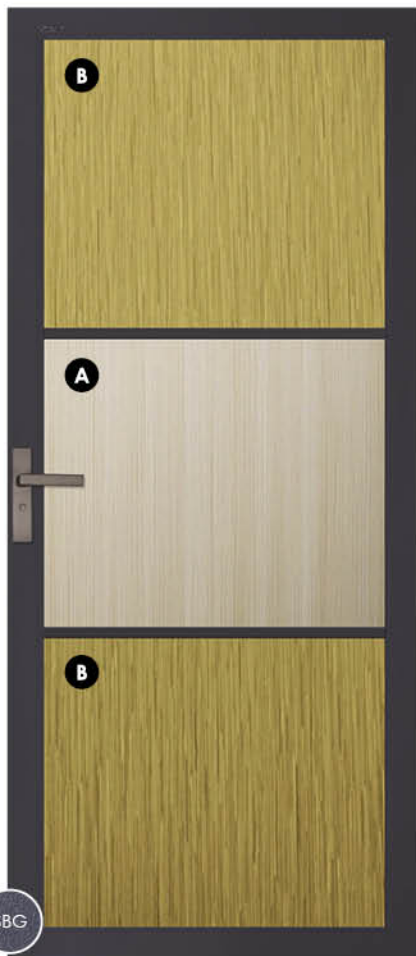

LATTICE MODEL: **SWC01**

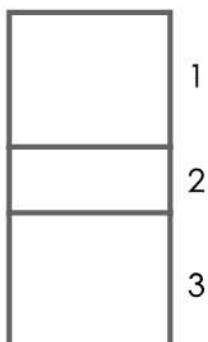

LATTICE MODEL: **SWC02**

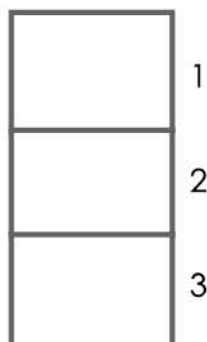

LATTICE MODEL: **SWC03**

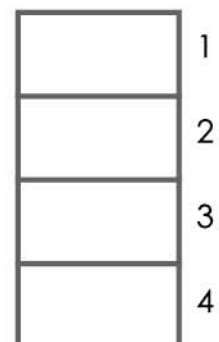

# aerolite™ Panel

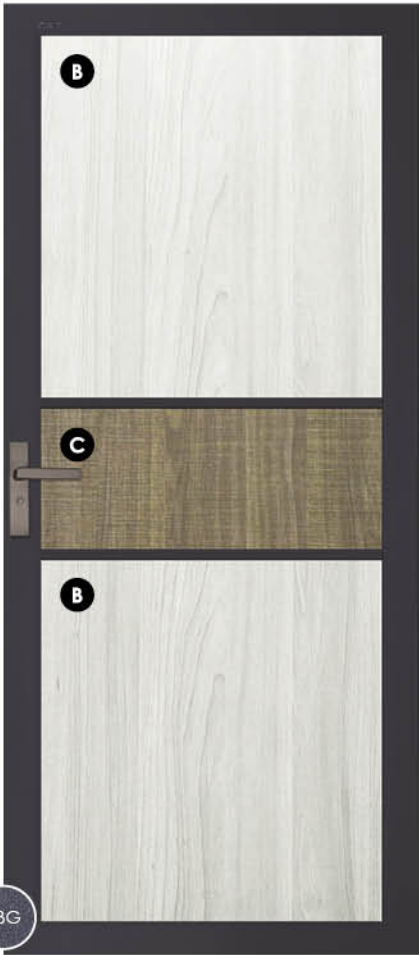

LATTICE MODEL: **SWC01**

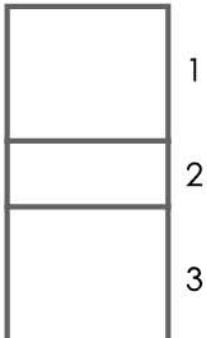

LATTICE MODEL: **SWC02**

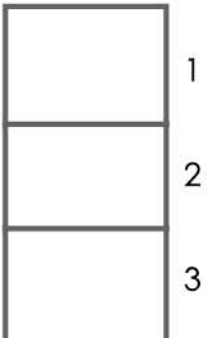

LATTICE MODEL: **SWC03**



All pictures shown are for illustration purpose only. Actual product may vary due to product enhancement.

## LATTICE DESIGN

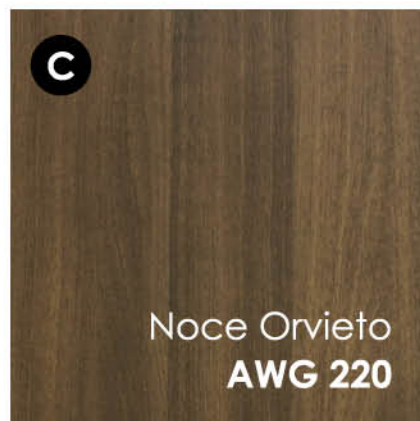
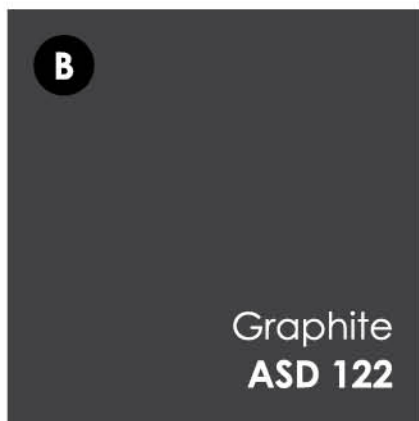
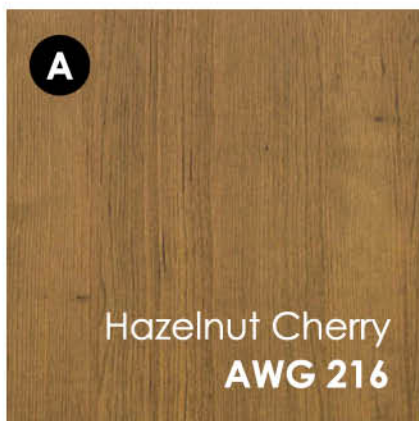

LATTICE MODEL: **SWC01**

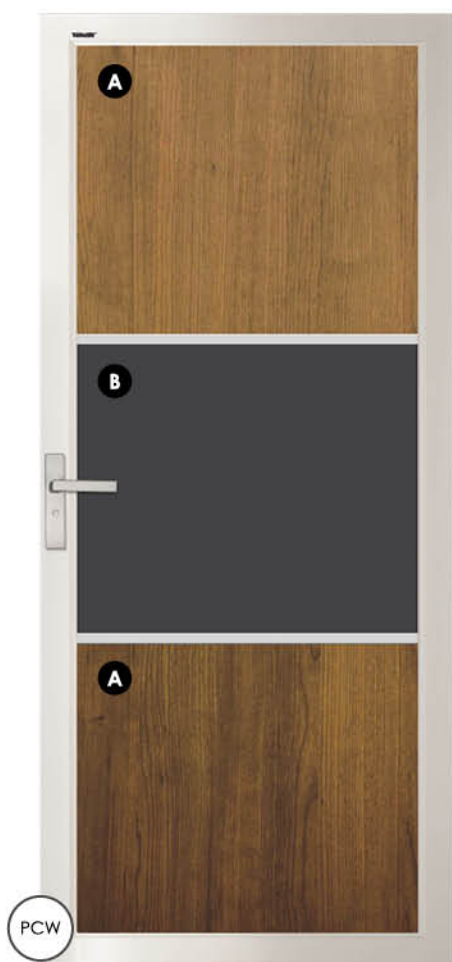

LATTICE MODEL: **SWC02**



LATTICE MODEL: **SWC03**

# aerolite™ Panel

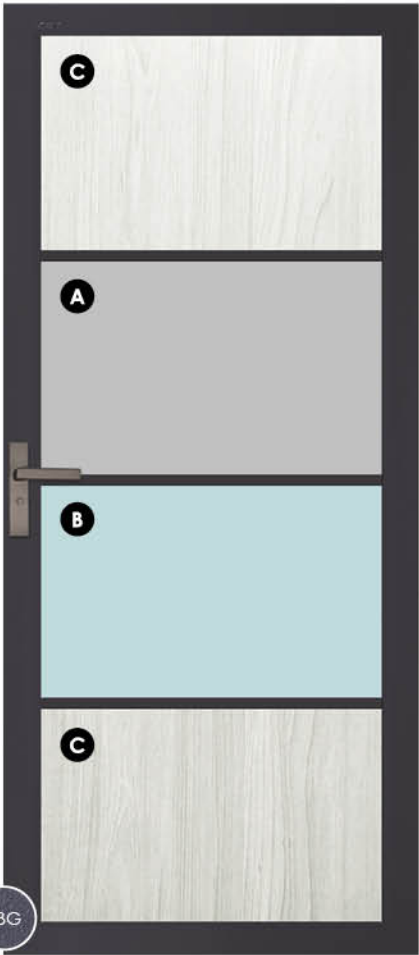
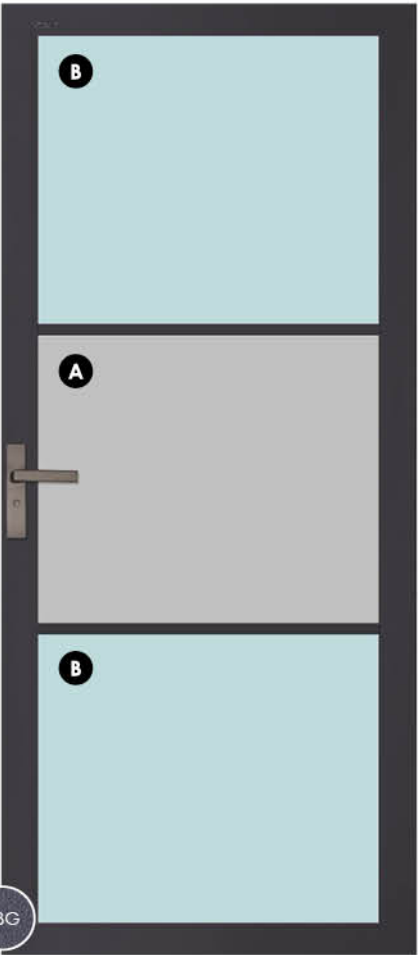
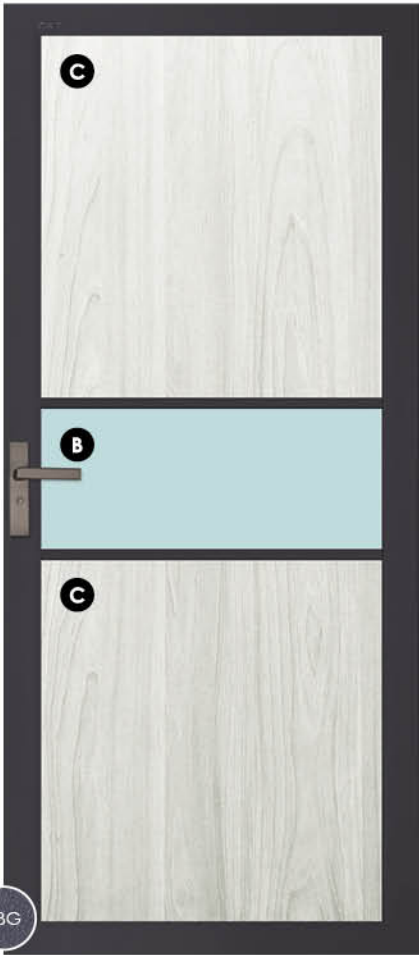

LATTICE MODEL: **SWC01**

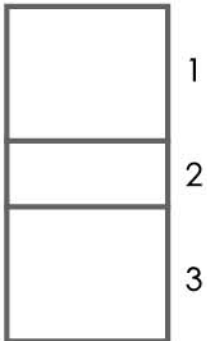

LATTICE MODEL: **SWC02**

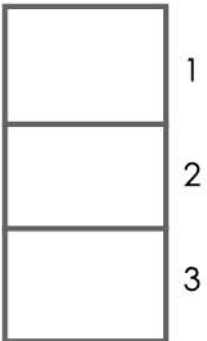

LATTICE MODEL: **SWC03**

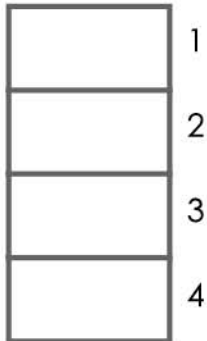

All pictures shown are for illustration purpose only. Actual product may vary due to product enhancement.

## LATTICE DESIGN

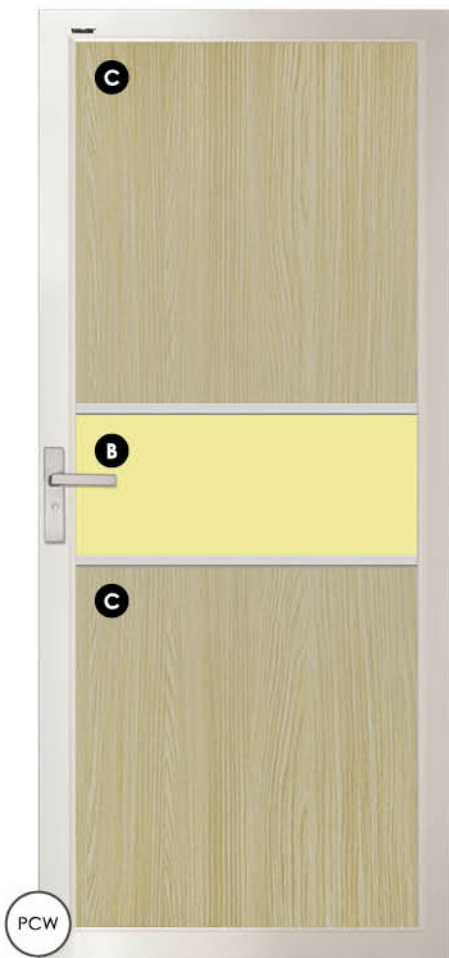
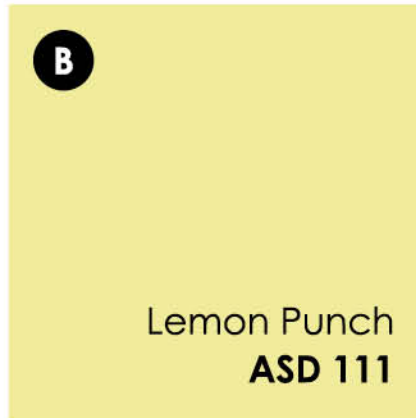
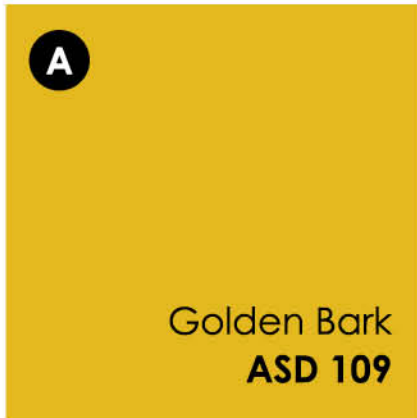

LATTICE MODEL: **SWC01**

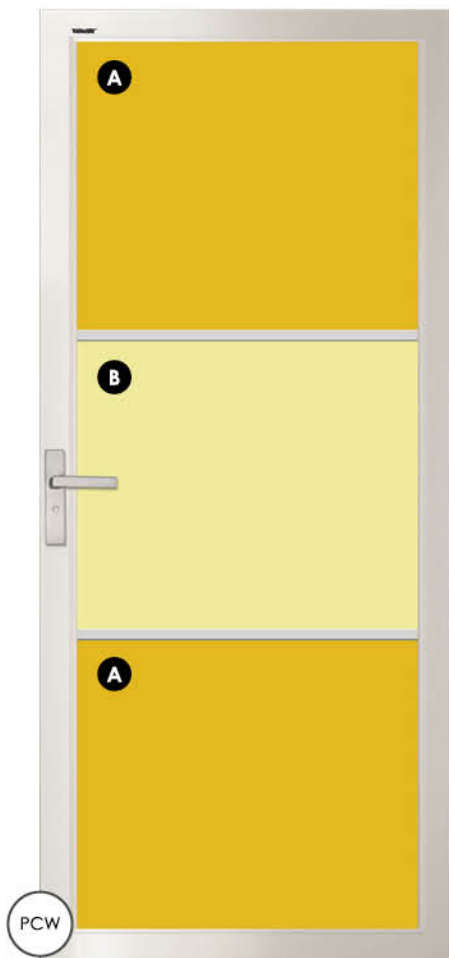

LATTICE MODEL: **SWC02**

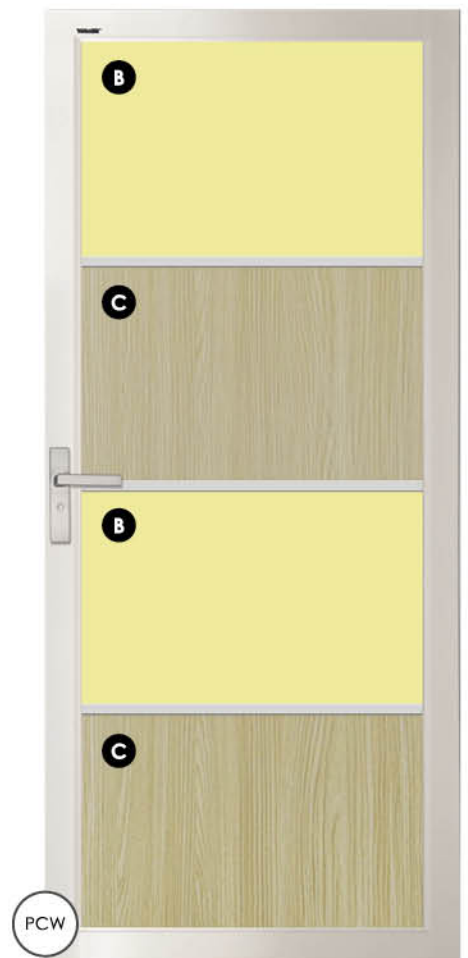

LATTICE MODEL: **SWC03**

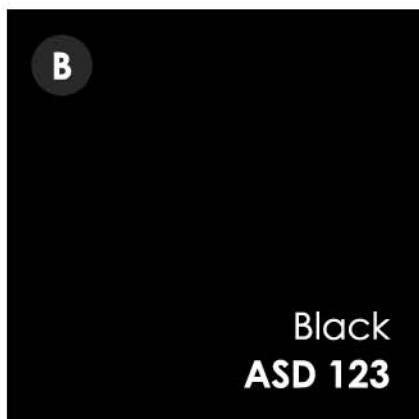
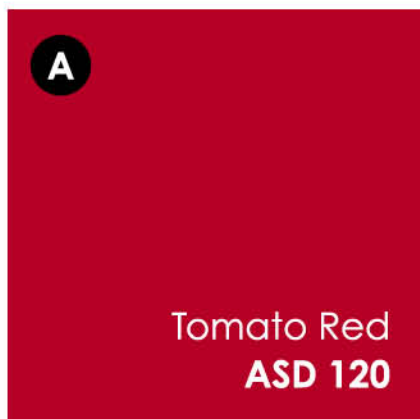

LATTICE MODEL: **SWC01**

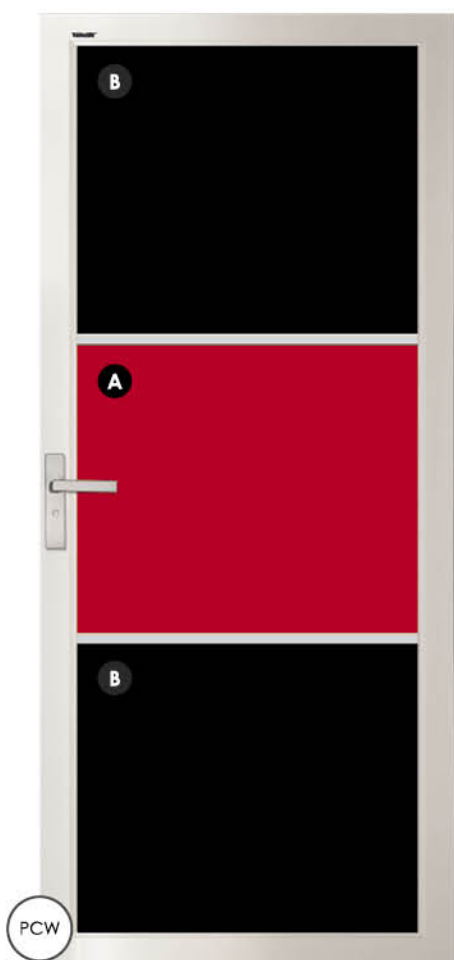

LATTICE MODEL: **SWC02**

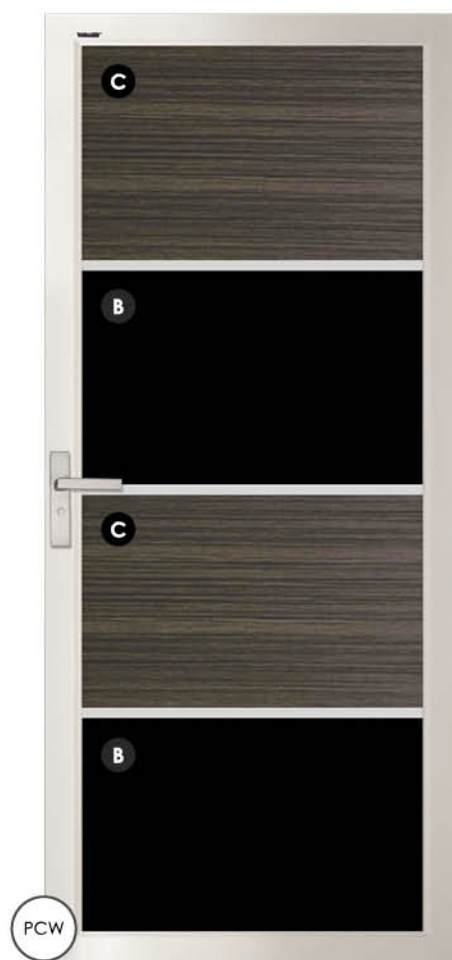

LATTICE MODEL: **SWC03**

# Lamina Glass

can be used on different products.

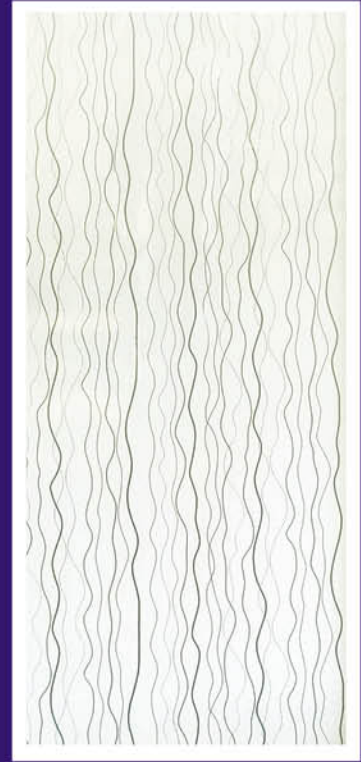

FC-7002

**SWING DOOR**



**BI-2 DOOR**



**BI-FOLD DOOR**



# Lamina Film

Enjoy an amazing life full of vibrance with our glass stickers



## PANEL COMPOSITION

- A** Glass
- B** Lamina Film

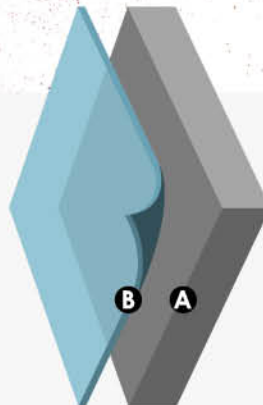



# Lamina Glass

## LATTICE DESIGN

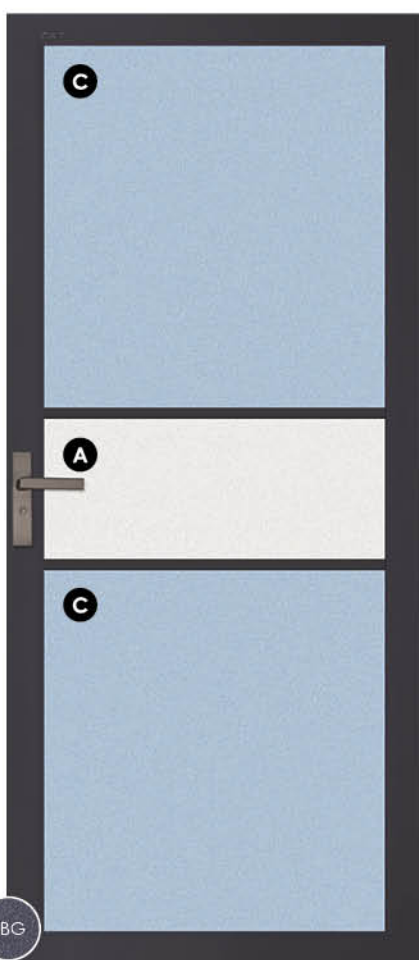
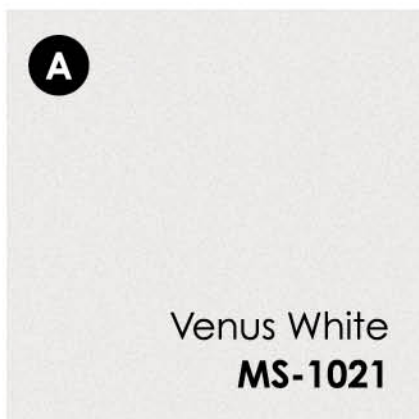

LATTICE MODEL: **SWC01**

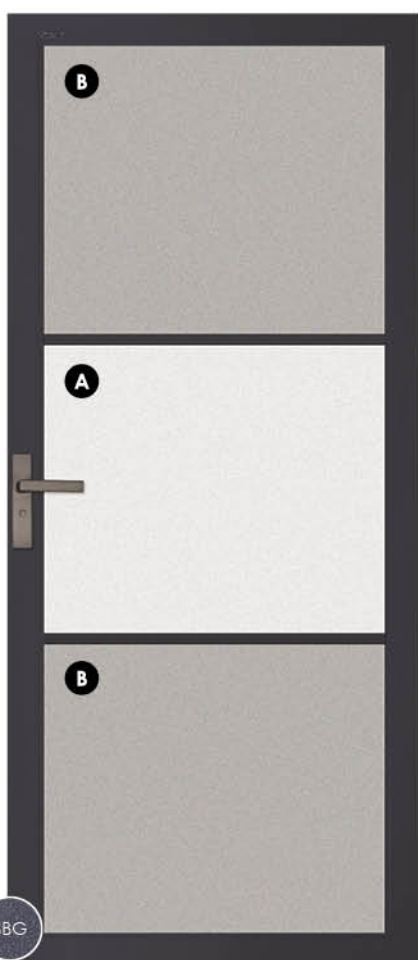
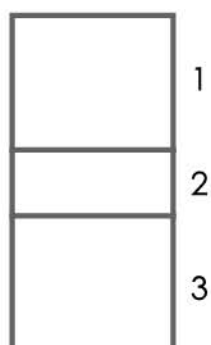

LATTICE MODEL: **SWC02**

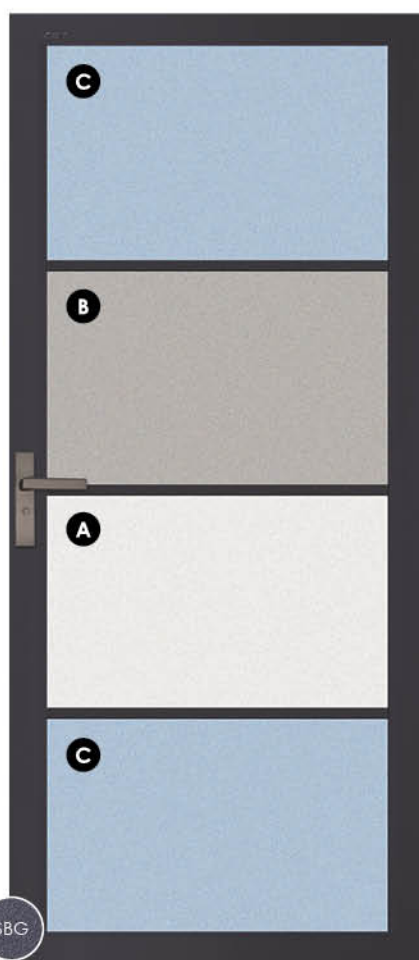
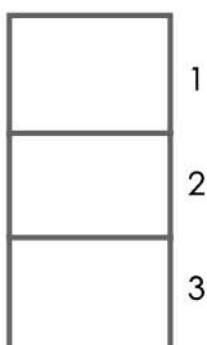

LATTICE MODEL: **SWC03**

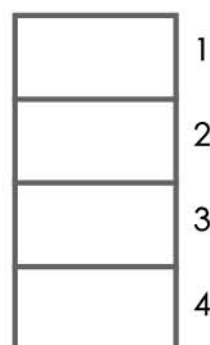

# Lamina Glass

## LATTICE DESIGN

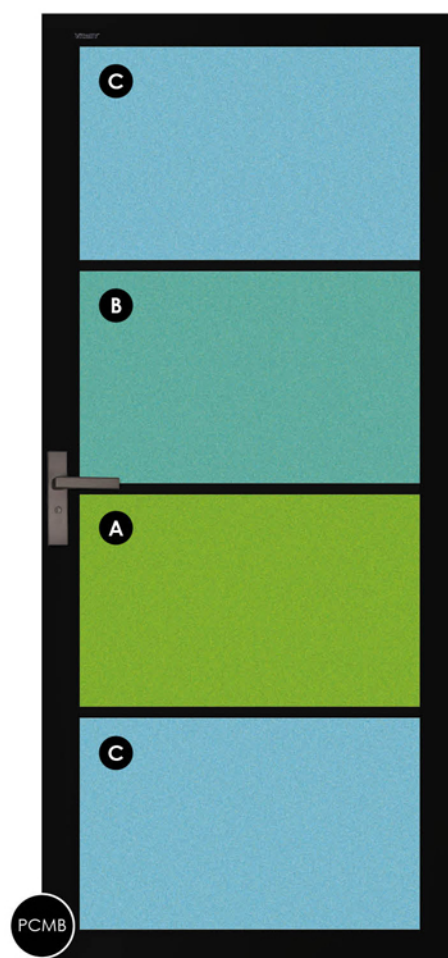
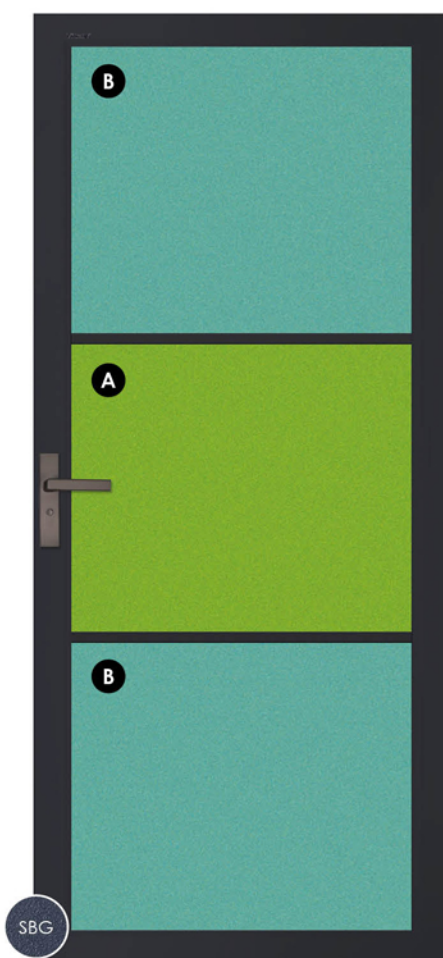
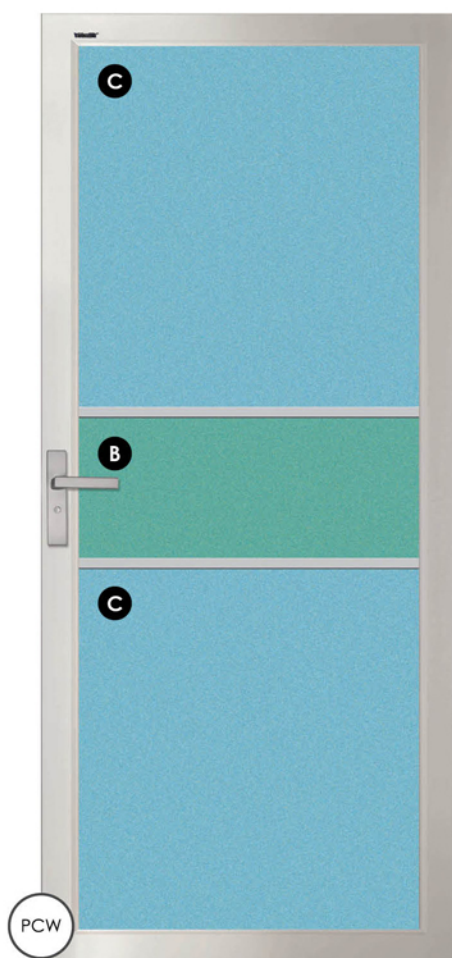
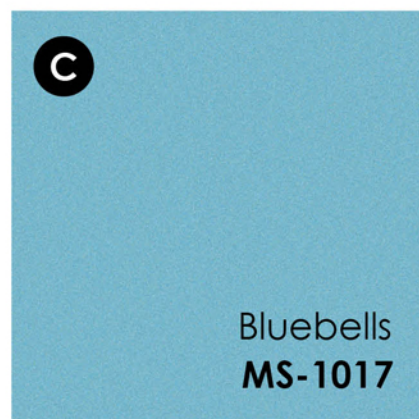
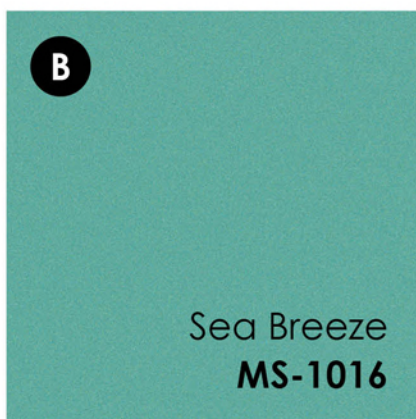
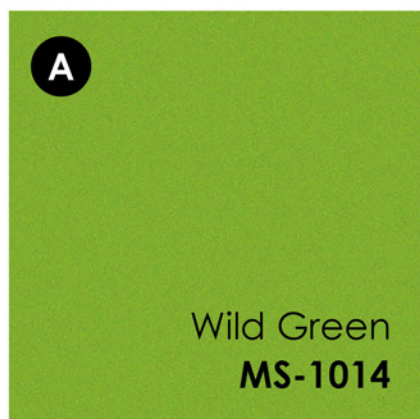

LATTICE MODEL: **SWC01**

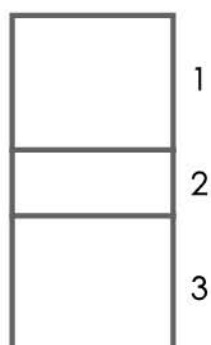

LATTICE MODEL: **SWC02**

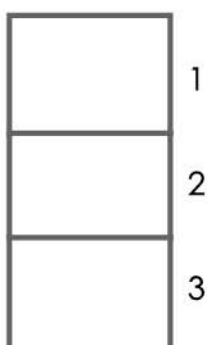

LATTICE MODEL: **SWC03**

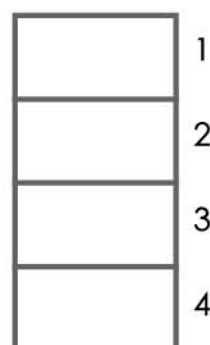

All pictures shown are for illustration purpose only. Actual product may vary due to product enhancement.



Lamina: MS-1017/ MS-1016/ MS-1014

# Lamina Glass

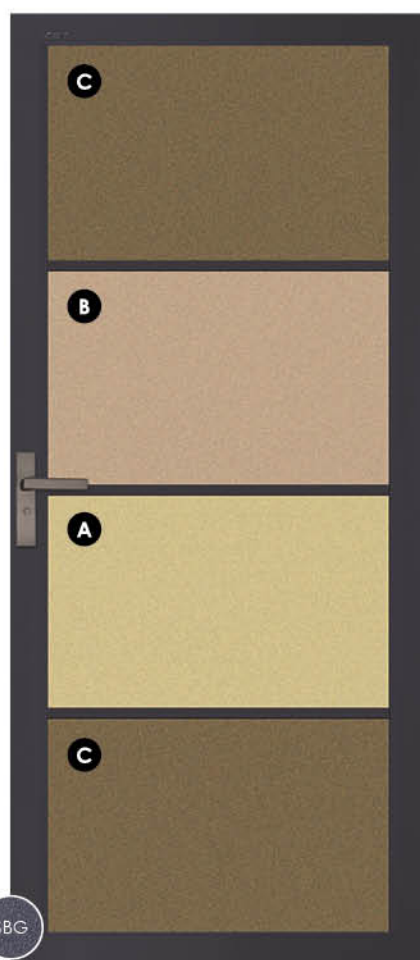
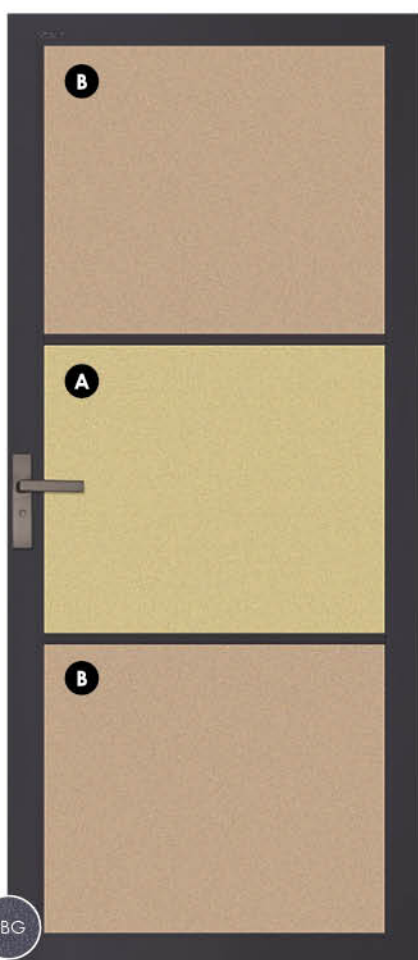
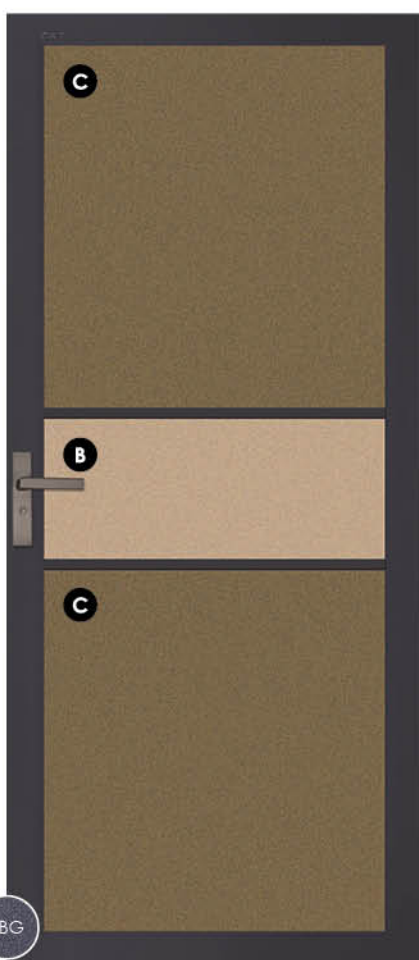
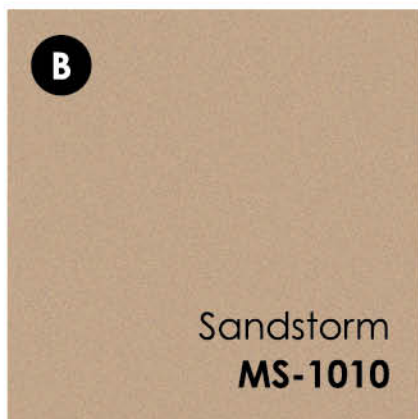

LATTICE MODEL: **SWC01**

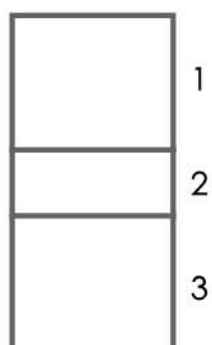

LATTICE MODEL: **SWC02**

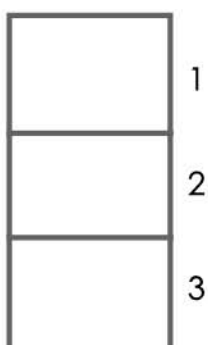

LATTICE MODEL: **SWC03**

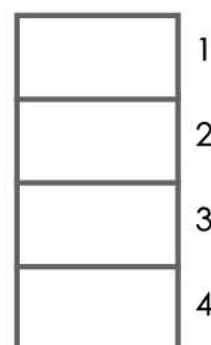

All pictures shown are for illustration purpose only. Actual product may vary due to product enhancement.

## LATTICE DESIGN

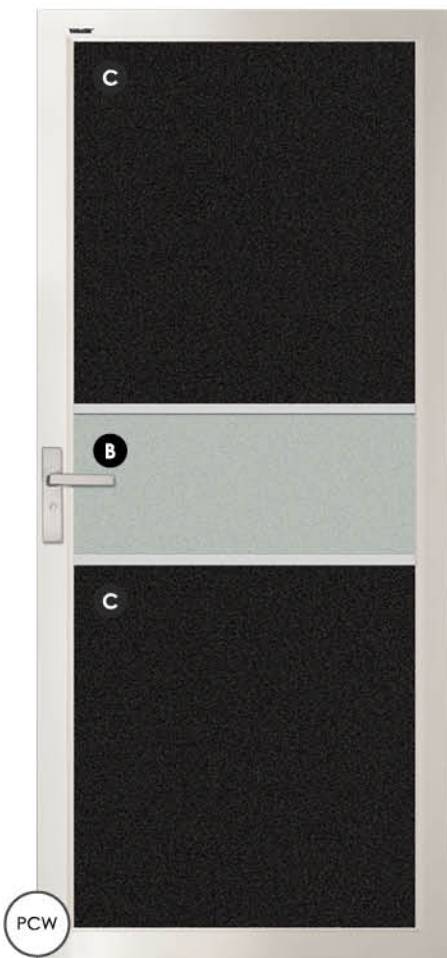
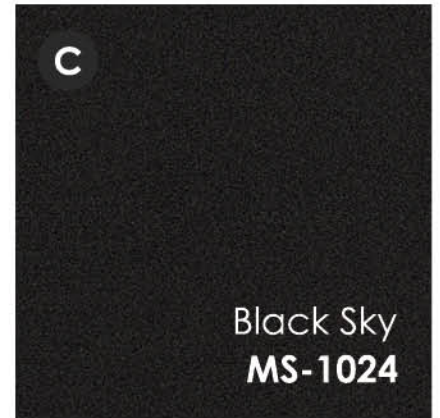
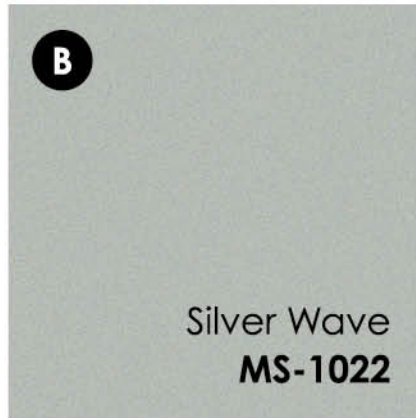
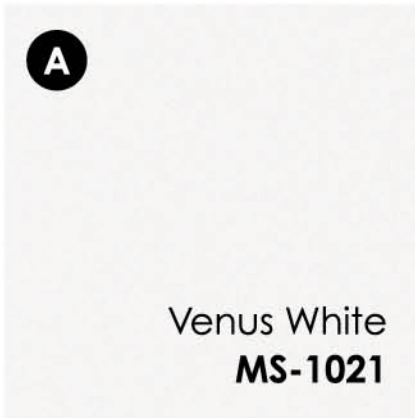

LATTICE MODEL: **SWC01**

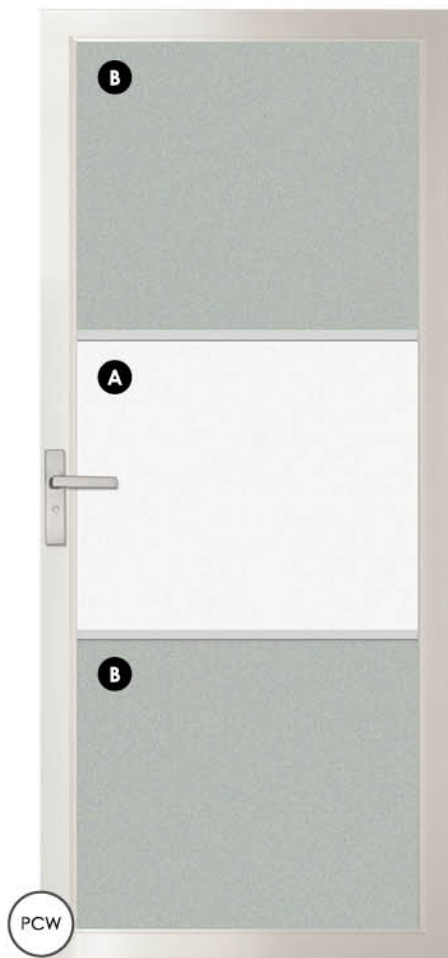

LATTICE MODEL: **SWC02**

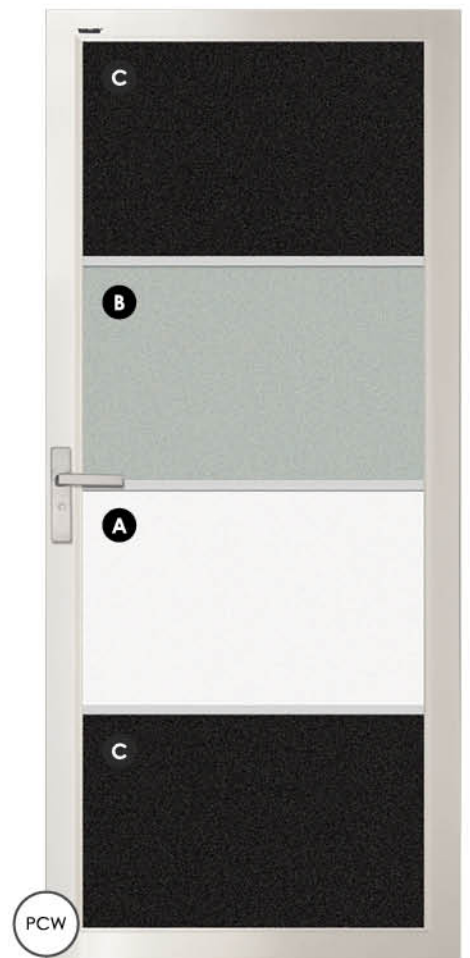

LATTICE MODEL: **SWC03**

# eco<sup>®</sup> ART PANEL

There are thousands of different designs to choose from.  
You will be spoilt for choice!

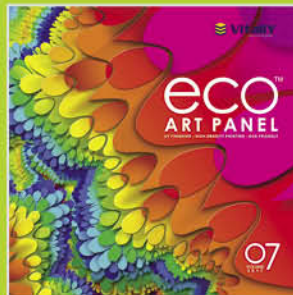

Visit our website for more designs:  
[www.vitaliy.com.my/e-catalog-category/eco-art-panel/](http://www.vitaliy.com.my/e-catalog-category/eco-art-panel/)

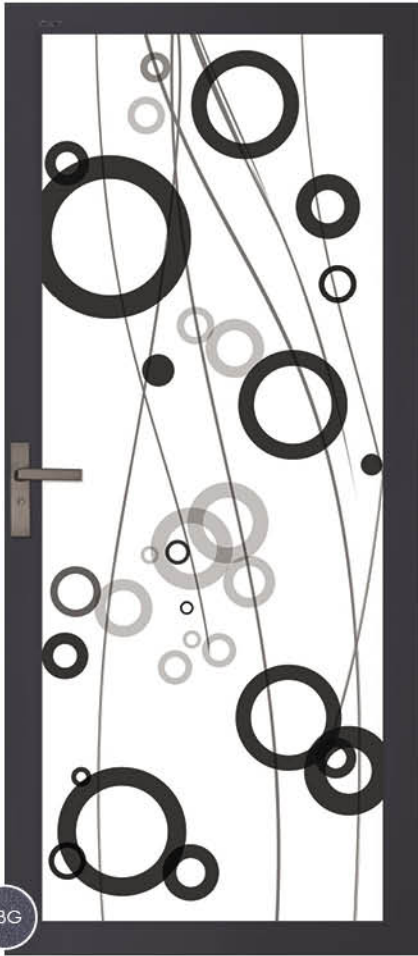

AM01011



AM01015

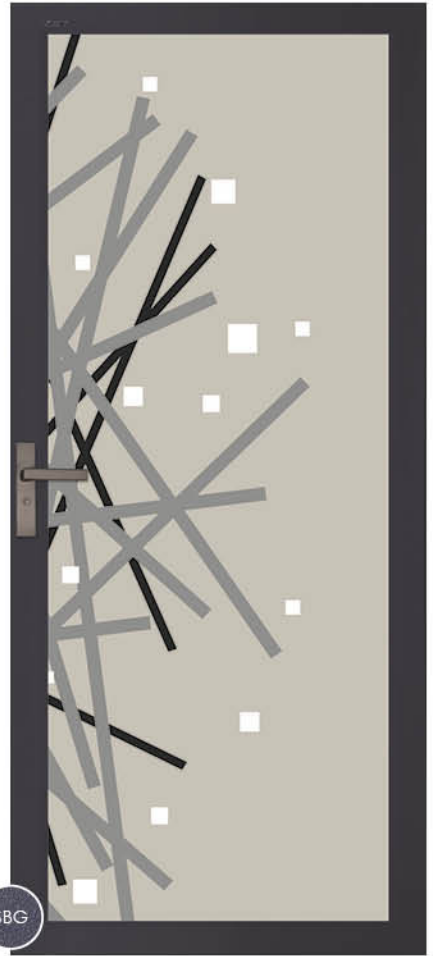

AM01020

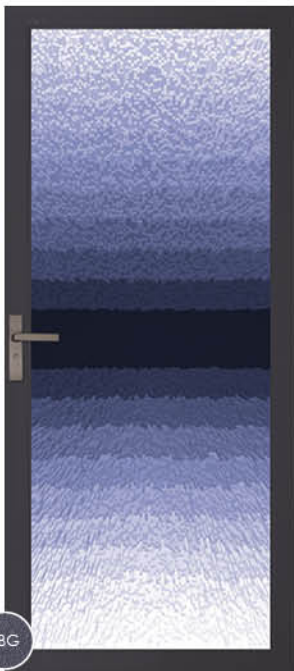

AM01021

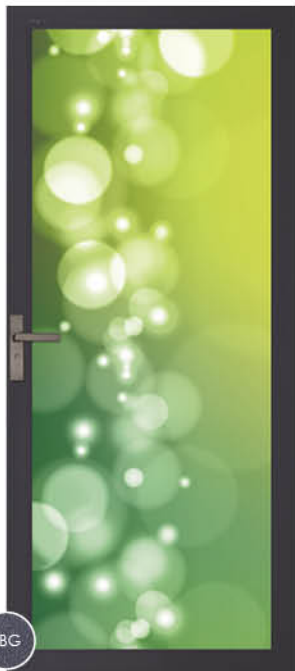

AM01024



AM01025



AM01048

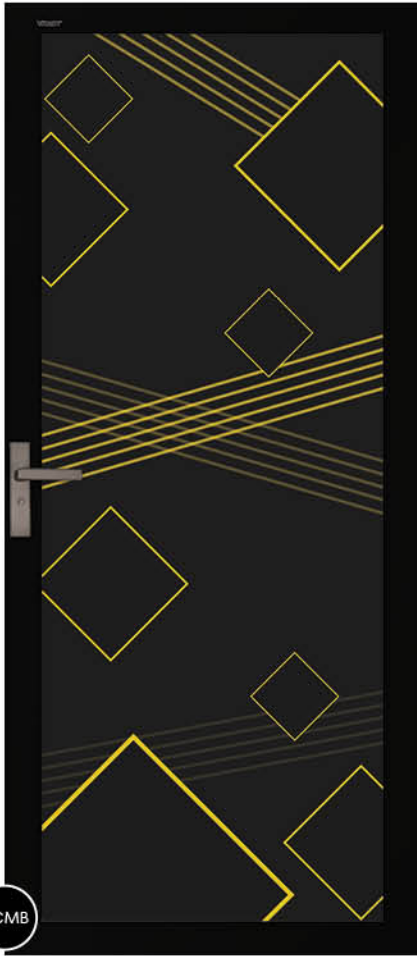

M112029



M112058



M112065



M112067

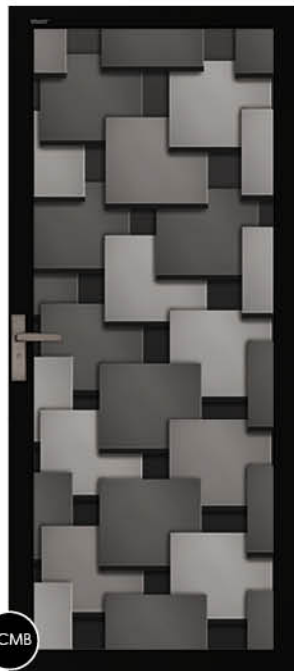

M112069



M112104



M112221



**Best Seller Design**  
from *Ilham Seni Vol.461*



BM01009



BM01025



BM01033



BM01038



BM01042



BM01054

All pictures shown are for illustration purpose only. Actual product may vary due to product enhancement.



BM01066



BM01067



BM01073



BM01077



BM01083



BM01084



BM01085

**Best Seller Design**  
from *Ilham Seni Vol.471*



BM71001



BM71006



BM71010



BM71011



BM71012



BM71031



BM71039

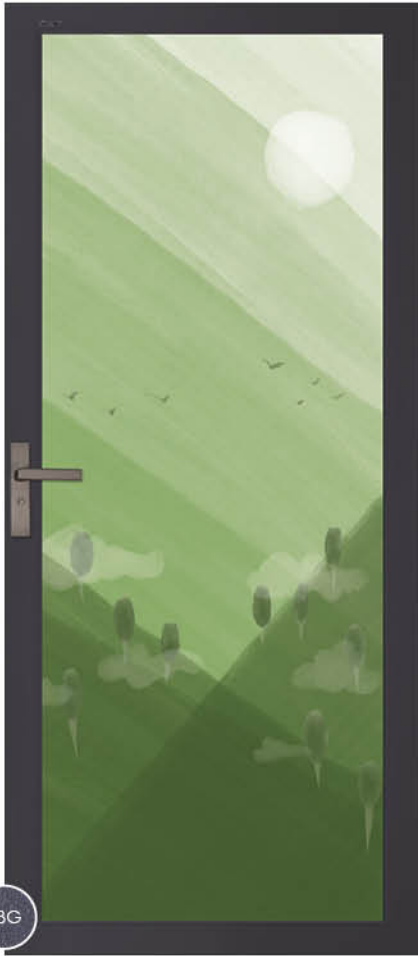

BM71040

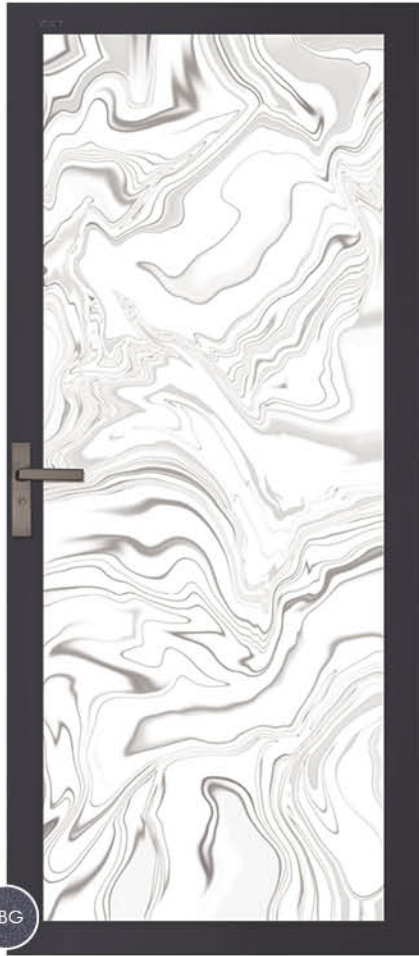

BM71044



BM71047



BM71049

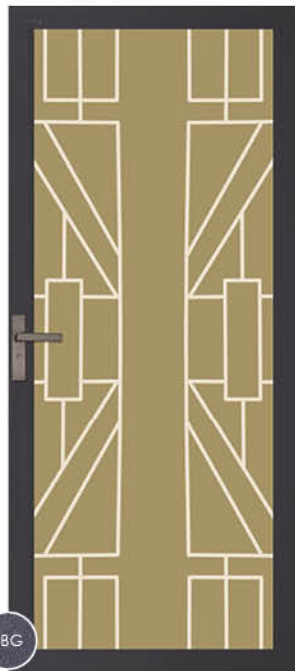

BM71053



BM71059



BM71060

## LATTICE DESIGN

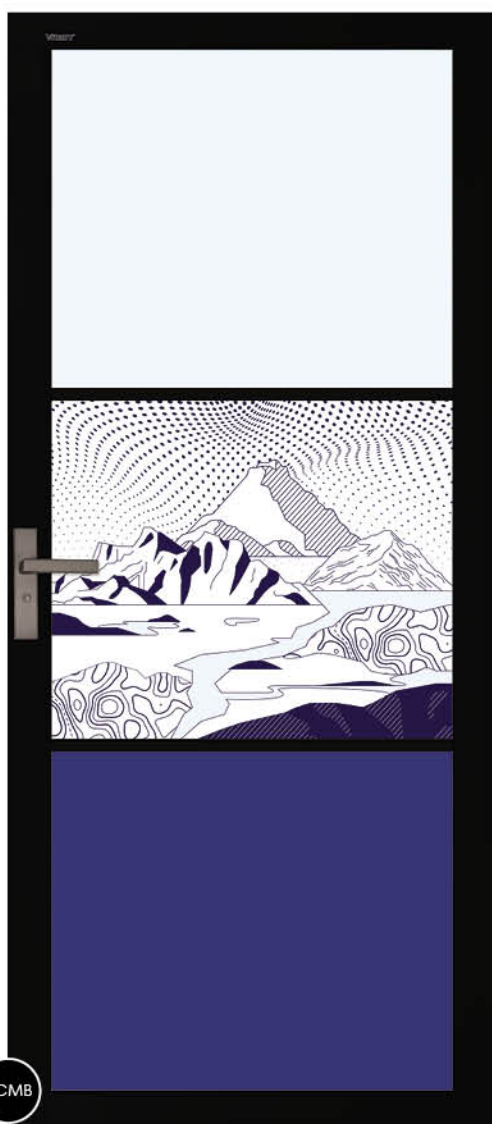

AL01265  
LATTICE MODEL: **SWC02**



AL01266  
LATTICE MODEL: **SWC01**

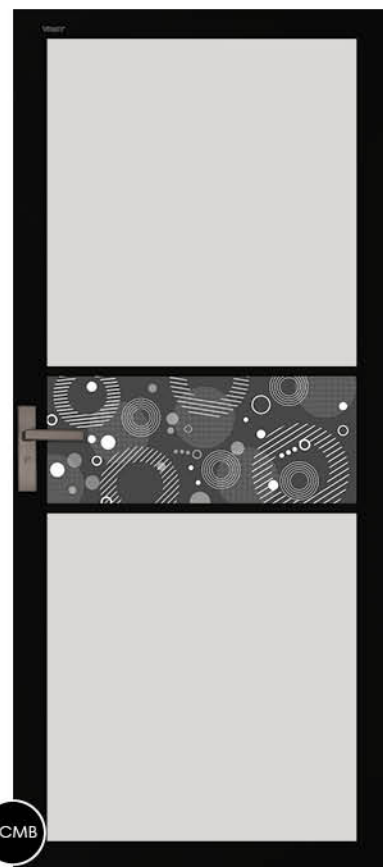

AL01267  
LATTICE MODEL: **SWC01**

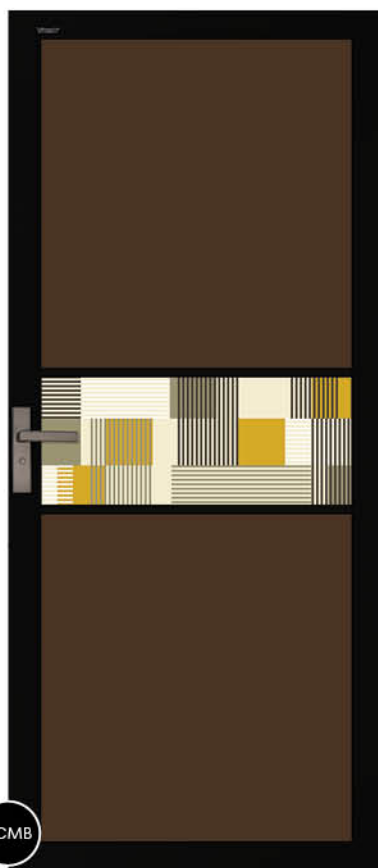

AL01268  
LATTICE MODEL: **SWC01**

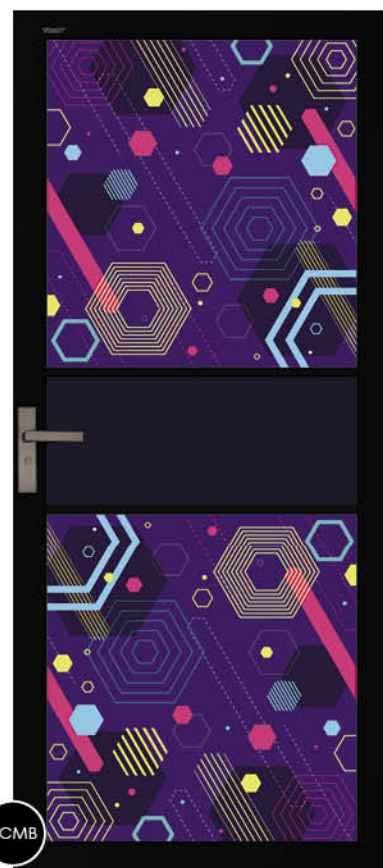

AL01269  
LATTICE MODEL: **SWC01**

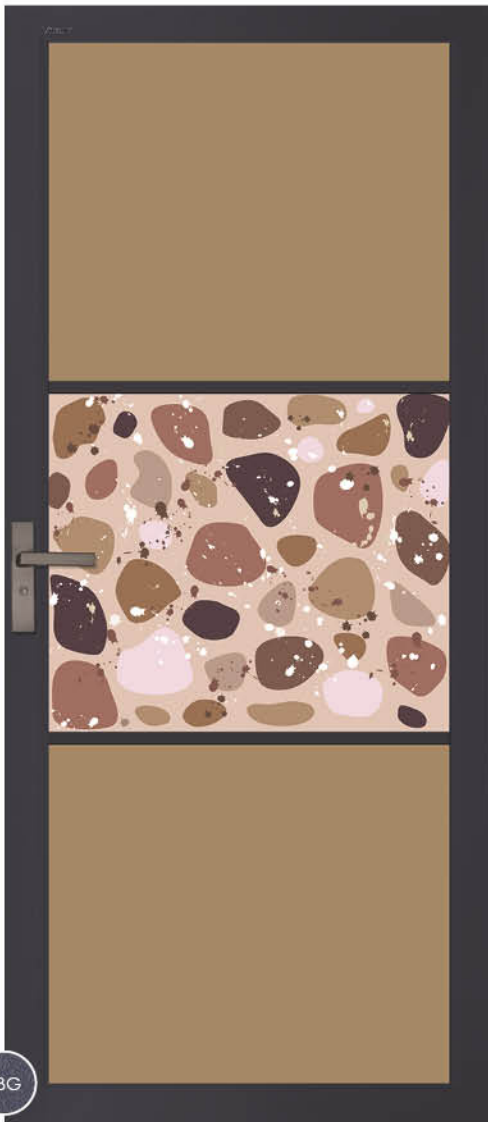

AL01270  
LATTICE MODEL: **SWC02**



AL01271  
LATTICE MODEL: **SWC03**



AL01272  
LATTICE MODEL: **SWC03**



AL01273  
LATTICE MODEL: **SWC03**



AL01274  
LATTICE MODEL: **SWC03**

## LOUVER DESIGN

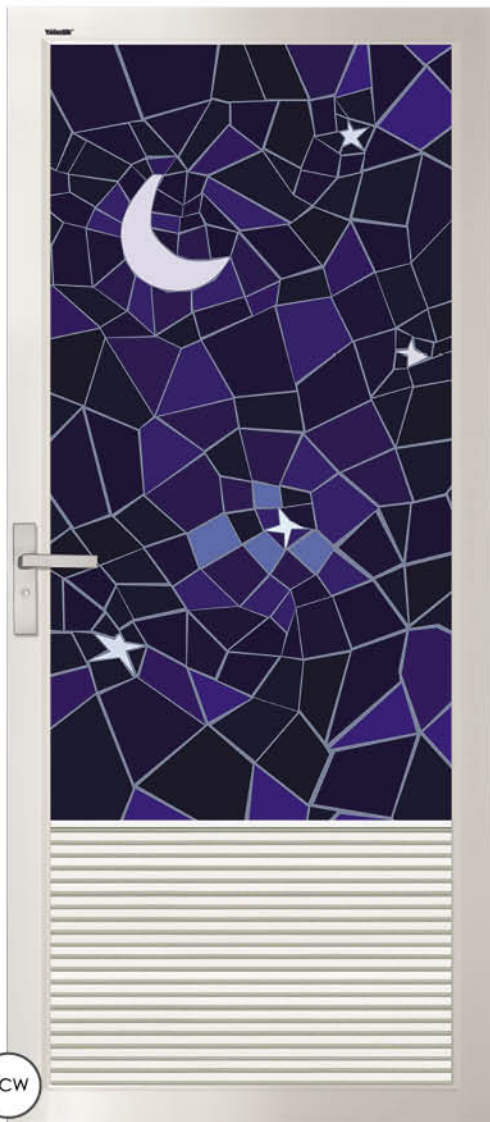

AL01275  
LOUVER MODEL: **SWV02**



AL01276  
LOUVER MODEL: **SWV02**



AL01277  
LOUVER MODEL: **SWV02**



AL01278  
LOUVER MODEL: **SWV02**



AL01279  
LOUVER MODEL: **SWV02**



AL01280  
LOUVER MODEL: **SWV02**



AL01281  
LOUVER MODEL: **SWV02**



AL01282  
LOUVER MODEL: **SWV02**



AL01283  
LOUVER MODEL: **SWV02**



AL01284  
LOUVER MODEL: **SWV02**





Aerolite: AWG 210



### UNOBSTRUCTED VIEW

The design of the infill panel is unobstructive, and does not block your eye-view.



### DOOR HANDLE

Hassle-free operation and user-friendly.

# Bi-fold Door (Bi-2) series

# aerolite™ Panel

Fineline  
**AWG 201**



Alabaster Oak  
**AWG 204**



Waterfall Line  
**AWG 203**



Wheat Strand  
**AWG 206**



Natural Ash  
**AWG 205**



Cross Oak  
**AWG 208**



# aerolite™ Panel

Smoked Pine  
**AWG 210**



Yellow Bamboo  
**AWG 211**



Burmese Teak  
**AWG 212**



All pictures shown are for illustration purpose only. Actual product may vary due to product enhancement.

Royal Elm  
**AWG 213**



Sarum Strand  
**AWG 214**



Classic Oak  
**AWG 215**





Aerolite: AWG 222

Hazelnut Cherry  
**AWG 216**



LOUVER MODEL: **B2V02**

Oiled Olivewood  
**AWG 218**



LOUVER MODEL: **B2V02**

Oiled Walnut  
**AWG 219**



LOUVER MODEL: **B2V02**

Couture Wood  
**AWG 222**



LOUVER MODEL: **B2V02**

Weathered Teak  
**AWG 223**



LOUVER MODEL: **B2V02**

Smoked Teak  
**AWG 228**



LOUVER MODEL: **B2V02**





Bi-2 with louver design  
is ideal for store room.

Aerolite: AWG 213

Apple Green  
**ASD 115**



LOUVER MODEL: **B2V02**

Apricot Crush  
**ASD 119**

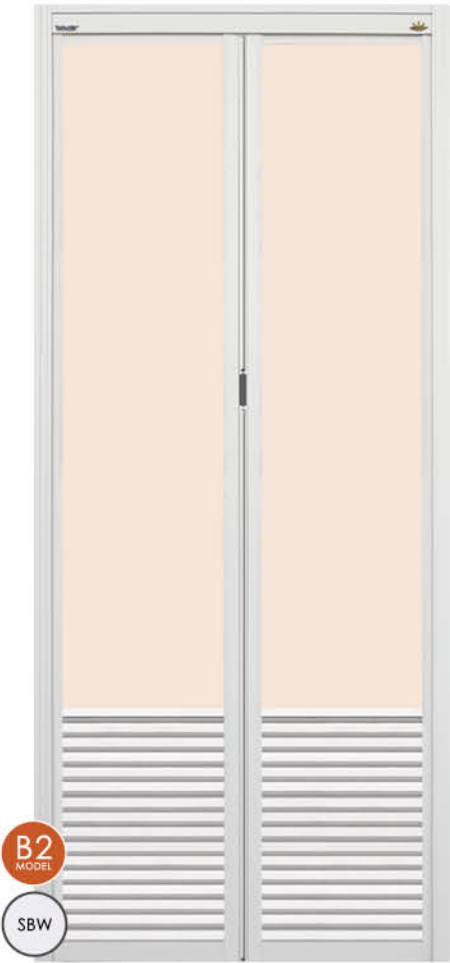

LOUVER MODEL: **B2V02**

Tomato Red  
**ASD 120**



LOUVER MODEL: **B2V02**

All pictures shown are for illustration purpose only. Actual product may vary due to product enhancement.

Fineline  
**AWG 201**



Burmese Teak  
**AWG 212**



Natural Ash  
**AWG 205**



# aerolite™ Panel

Classic Oak  
**AWG 215**



Oiled Olivewood  
**AWG 218**



Noce Orvieto  
**AWG 220**



# eco<sup>®</sup> ART PANEL

can be used on different products.



AM01048

## SWING DOOR



## BI-2 DOOR



## BI-FOLD DOOR





AM01031



AM01035



AM01038

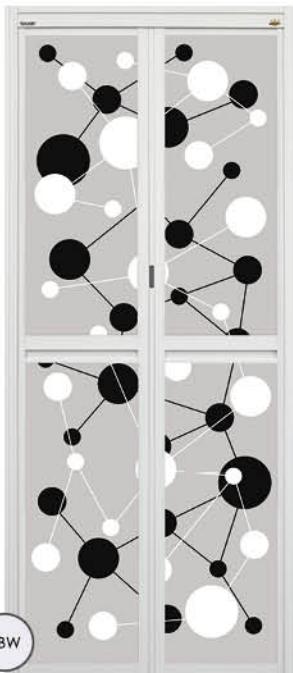

AM01061



AM01071



AM01083



AM01091

**Best Seller Design**  
**from Ilham Seni Vol.461**



BM01008



BM01016



BM01034



BM01047



BM01048



BM01053

All pictures shown are for illustration purpose only. Actual product may vary due to product enhancement.

# TYPES OF INFILL PANEL

## AEROLITE PANEL

30 Woodgrain and 20 solid colours with different visual effects for selection.

### SOLID COLOURS



TANGERINE TWIST  
ASD 108



GOLDEN BARK  
ASD 109



LIGHT GREY  
ASD 110



LEMON PUNCH  
ASD 111



APPLE GREEN  
ASD 115

### WOODGRAIN



FINELINE  
AWG 201



WATERFALL LINE  
AWG 203



WHEAT STRAND  
AWG 206



BURMESE TEAK  
AWG 212



HAZELNUT CHERRY  
AWG 216

## LAMINA GLASS

72 colours with different visual effects for selection.



MS-1021  
VENUS WHITE



MS-1024  
BLACK SKY



MT-2001  
TITAN RED



MT-2003  
TITAN PURPLE



SD-3001  
SNOW WHITE

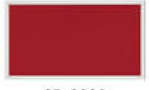

SD-3002  
CHANSEY RED



WG-4001  
SKYLINE



WG-4003  
ICELAND



GX-5001  
GALAXY WHITE



GX-5004  
GALAXY BLACK



TC-6502  
FROSTED WHITE



TC-6505  
FROSTED PINK



FC-7001  
FLOW BLACK



FC-7002  
FLOW WHITE

## ECO ART PANEL

There are thousands of different design for selection.

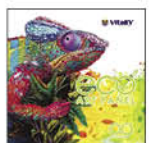

Visit our website for more colours:  
[www.vitaly.com.my/e-catalog-category/others-panel/](http://www.vitaly.com.my/e-catalog-category/others-panel/)



Visit our website for more colours:  
[www.vitaly.com.my/product-category/panel-types/lamina-glass/](http://www.vitaly.com.my/product-category/panel-types/lamina-glass/)



Visit our website for more designs:  
[www.vitaly.com.my/e-catalog-category/eco-art-panel/](http://www.vitaly.com.my/e-catalog-category/eco-art-panel/)



# Installation Guide for Swing Door

## 1 Preparation of Tools

Prepare the tools as shown below for the installation process.



Cordless Drill

or



Philip Head  
Screw Driver



Measuring Tape



Self Tapping Screw  
#8 x 1/2" (24 PCS)

## 2 Check door dimension

By using a measuring tape, record the minimum measurement for height (H) and width (W) of the door frame.

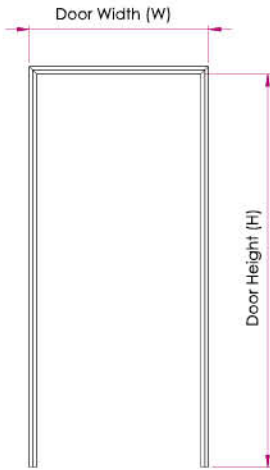

Swing Door Size

$$\begin{aligned} &= H \times W \\ &= (H \text{ min} - 8/16") \times (W \text{ min} - 5/16") \end{aligned}$$

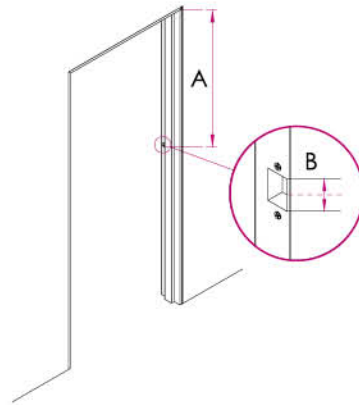

Measurement of Door Shaft Hole

$$= A - B/2 - 2/16"$$

## 3 Assemble the hinges on the swing door.

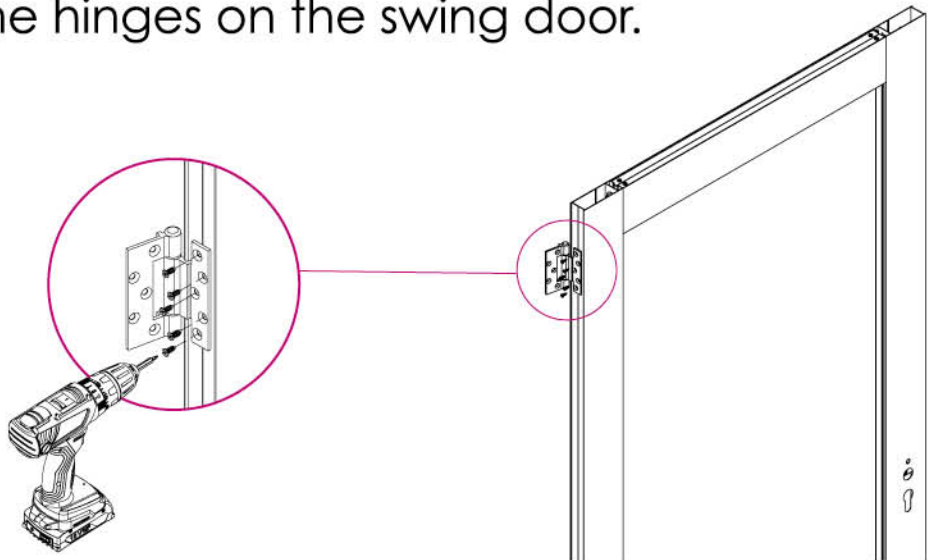

## 4 Assembling hinger screws

Before assembling a full set of screws, drill a few screws on each hinge first to fix the door frame hole in its position.

Drill a few more screws on the upper and lower hingers.

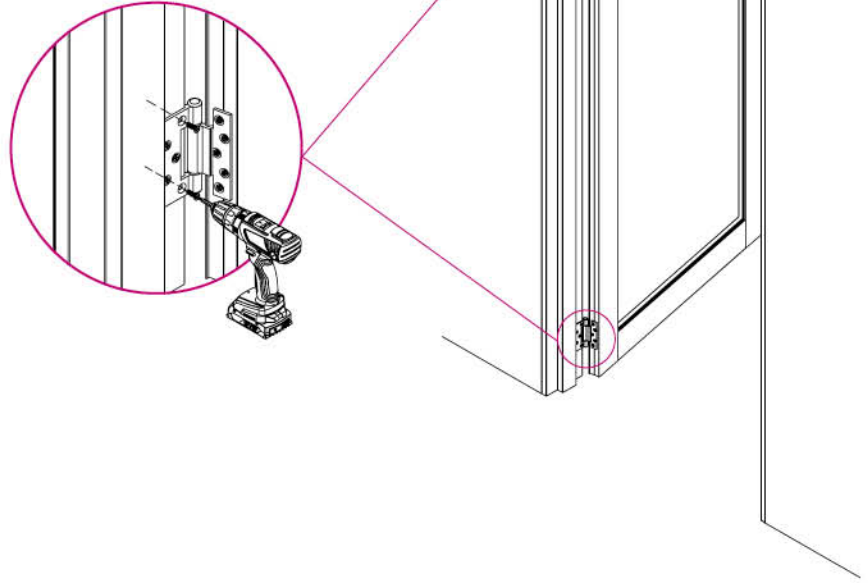

## 5 Drill hole of shaft door on the door frame.

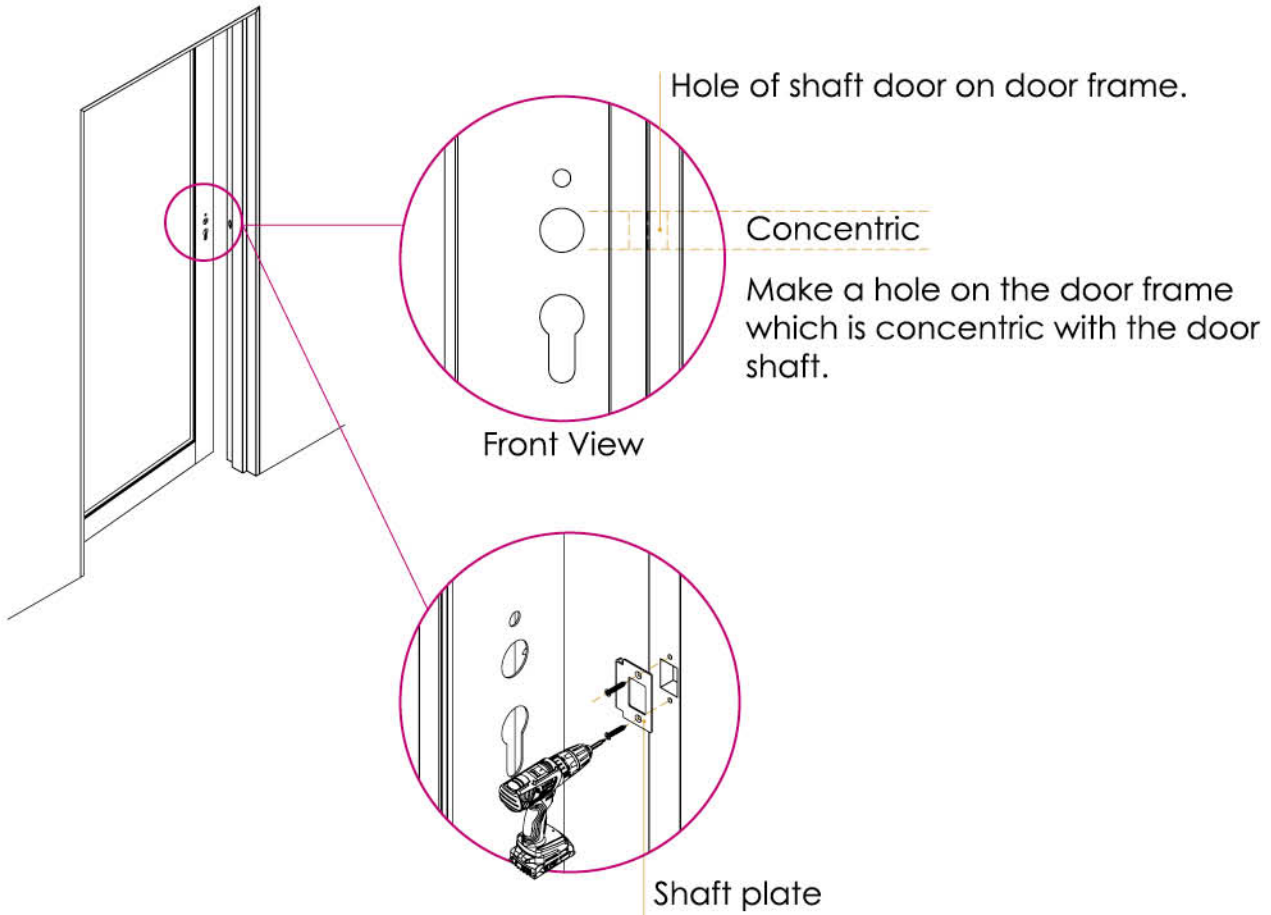

## 6 Assembling all the hinge screws

Install the rest of the hinge screws.

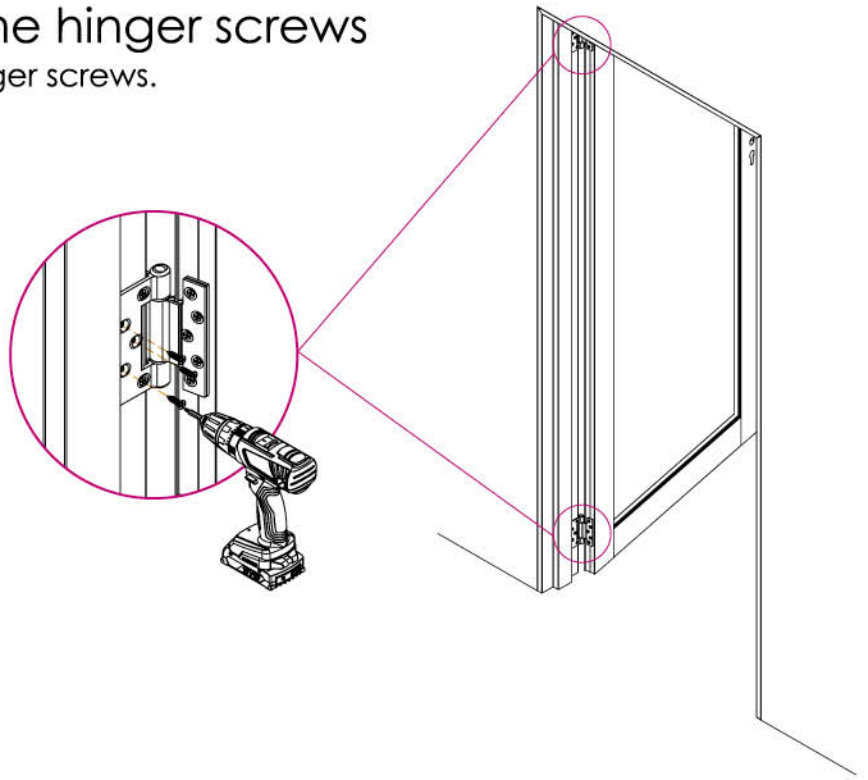

## 7 Assemble the handle lock

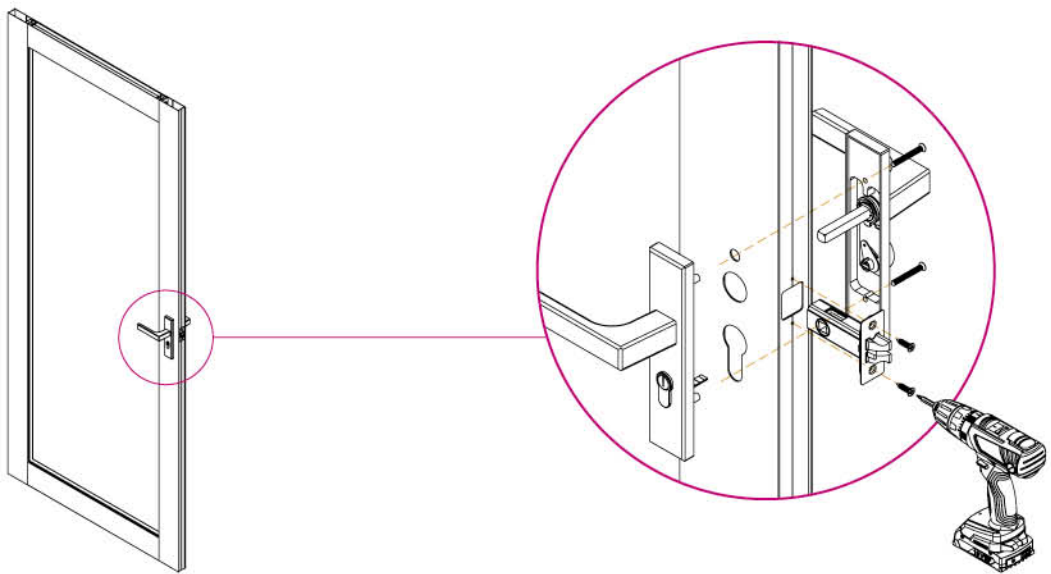

Open and close the door several times to ensure that the door lock is fully functional.

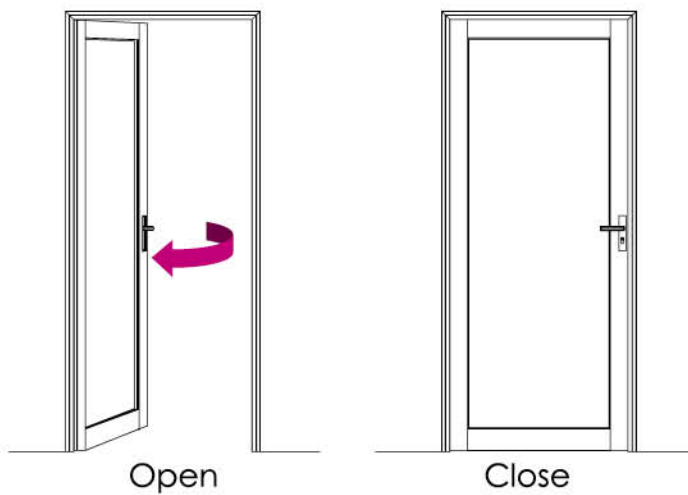

**CHOOSE THE BEST KITCHEN DOOR WITH  
VITALITY FULL LOUVER SWING DOOR.**



Louver Model: SWV00

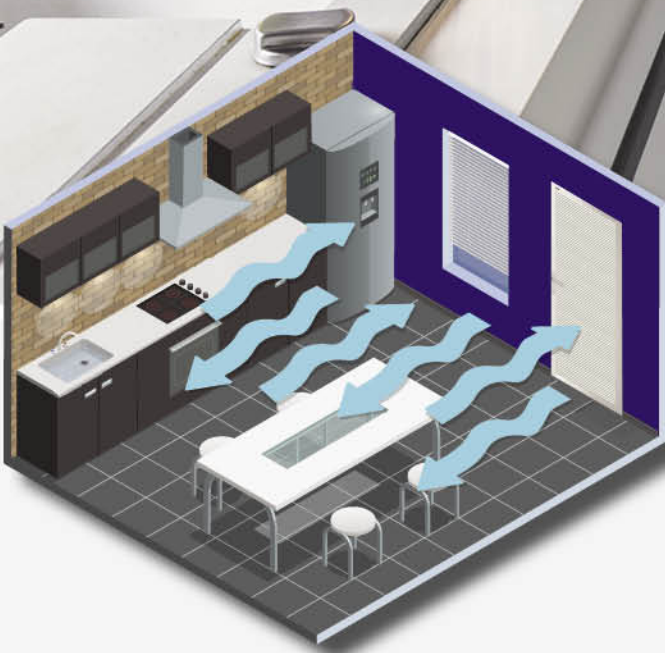

## **LOUVER DESIGN**

Special Louver designs provide great ventilation allowing air to flow through.

- Ventilation
- Remove Odor
- Reduce Humidity

Louver design will help to improve our fresh indoor.